

GE  
Sensing

# Druck UPS-III Loop Calibrator

User manual -K0317

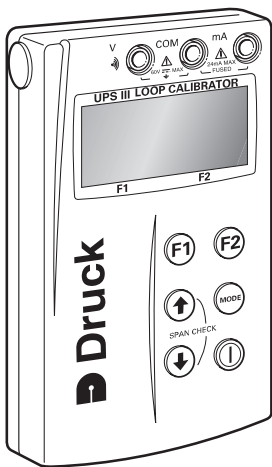

## Approved Service Agents

For the list of service centres visit our web site:

[www.gesensing.com](http://www.gesensing.com)

### Symbols



This equipment meets the requirements of all relevant European safety directives. The equipment carries the CE mark.



This symbol, on the instrument, indicates that the user should refer to the user manual.



Do not dispose of this product as household waste. Use an approved organisation that collects and/or recycles waste electrical and electronic equipment. For more information:

Contact us at [www.gesensing.com](http://www.gesensing.com)

# UPS III Loop Calibrator

## Introduction

The Druck UPS III Series of loop calibrators can supply power (**source mode**) and produce readings (**measure mode**) to perform field calibrations on 2-wire devices. The set-up menu enables the user to "source" or "measure" in either voltage or current and to perform continuity tests. These user instructions include the operation, safety instructions and installation requirements for the loop calibrator.

## Specifications

### Accuracy

Values in table below includes temperature effects 17°C to 27°C  
 Outside these limits ..... 0.003%/°C(0.0015%/°F)  
 Calibration Reference..... 22°C ±1°C/RH45%±15%

| Mode             | Range       | Accuracy          | Remarks            |
|------------------|-------------|-------------------|--------------------|
| Source mA        | 0 to 24 mA* | 0.01% rdg + 2 lsd | V-max. 75V         |
| Source mA + 24V  | 0 to 24 mA* | 0.01% rdg + 2 lsd | R-max 1kΩ at 20 mA |
| Measure mA       | 0 to 24 mA* | 0.01% rdg + 2 lsd | V-max. 75V         |
| Measure mA + 24V | 0 to 24 mA* | 0.01% rdg + 2 lsd | R-measure 15Ω      |
| Measure V        | 0 to 60V*   | 0.02% rdg + 4 lsd | R-measure 1MΩ      |
| Continuity       | <100Ω **    | -                 | 1 mA               |

\* Resolution 0.001

lsd least significant digits

\*\* Audio + visual

rdg reading

Hart® communications.....menu selectable 220Ω loop resistor

Operating Temperature..... -10°C to 50°C (-14°F to 122°F)

Storage Temperature..... -20°C to 70°C (-4°F to 158°F)



This loop calibrator meets the essential protection requirements of the relevant EEC directives.

Conforms to ..... EN61010, EN 61326-1(1997)+ A1(1998)

### Electrical Power Supply

..... 4 x 1.5 V alkaline size AA or  
 Universal power supply {see accessories}

## Physical

|                        |                                |
|------------------------|--------------------------------|
| Dimensions.....        | 77 x 129 x 24 mm(3" x 5" x 1") |
| Weight .....           | 275 grams (9.7 oz.)            |
| Terminals .....        | 4 mm sockets {gold plated}     |
| Case .....             | High impact ABS                |
| Relative Humidity..... | 0 to 90%                       |

## Safety



This symbol, on the loop calibrator, indicates that the user should refer to the user guide or manual.

## Batteries

- Remove batteries from the loop calibrator immediately when discharged and before storage.
- Dispose of batteries in accordance with local regulations and battery manufacturers' instructions.
- When storing and transporting batteries make sure they cannot be short circuited.

## Power Supply

The power supply for this loop calibrator can be the internal non-rechargeable batteries or the external Universal power supply unit (see accessories).

|                     |                                   |
|---------------------|-----------------------------------|
| <b>Battery life</b> | ≥ 75 hours in measure mode        |
|                     | ≥ 18 hours at 12 mA (source mode) |

The display shows  with low battery power.

## Battery Replacement

- Unscrew and remove the securing screw from the battery panel.
- Replace the batteries, check the polarity of the batteries.
- Refit and secure the battery panel.

## Accessories



|          |   |
|----------|---|
| Assy 305 | Test lead set                                   |
| 191-129  | Power supply, Universal, 100-240 V a.c. 47-63Hz |
| 38016    | Carrying case                                   |
| 38023    | Protective rubber boot                          |



## OPERATION

### Keys

The  key switches the calibrator on and off. Press and hold for 2 seconds.

The  key changes the measure or source operating mode. Pressing the

  keys makes menu selections, sets numerical values and controls step and ramp functions (up/down).

The   select advanced functions shown on the bottom of the display. When no key is pressed for 10 minutes, the calibrator times out and switches off. To disable this automatic time out, select **outpower down** in the set-up menu.



## Operating Modes

Pressing **(I)** switches the instrument on and the display shows the start-up sequence. Pressing **(F1)**, at this time, the display shows the information screen:

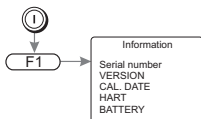

Pressing **(F2)**, at this time, the display shows the set-up screen:

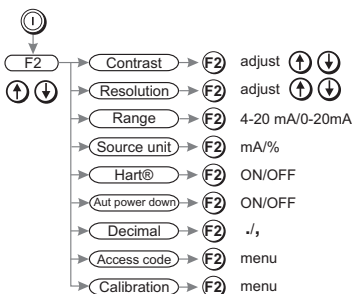

The calibrator can be used in two modes **measure** or **source**.

## Measure mode

The display shows the measured value; depending on the settings made in set-up and advanced settings:

When measuring current pressing **(F1)** enables linear or flow, pressing **(F2)** enables mA or % (value of 4 to 20 mA or 0 to 20 mA).

When measuring voltage pressing **(F2)** changes the resolution between 0.00V and 0.000V.

To measure continuity the displays shows an open or closed switch symbol with an audible signal on switch closure.

Connect the loop calibrator to the device to be tested:

### 1 and 2 Measure mA

Press the **mode** key and select [Measure mA]. External power supplies  $V_{max} = 60\text{ V}$  for the loop. The calibrator measures the current flow of the loop.

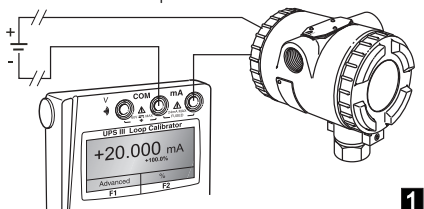

Closed loop current measurement from transmitter test terminal.

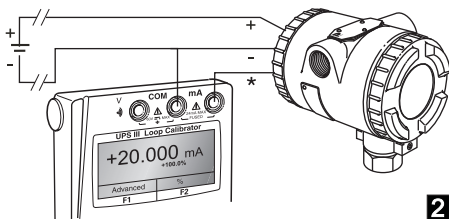

\* test terminal

### 3 Measure mA with 24 V

Press **mode** key and select [Measure mA and 24V]. The calibrator supplies 24 V for the loop, maximum 24 mA

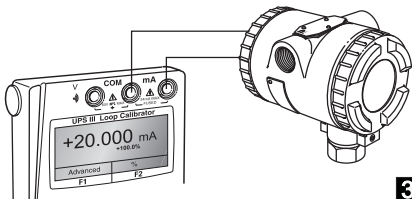

#### 4 Measure Volts

Press **mode** key and select [Measure V], measure range 60V, maximum impedance 1 Mohm.

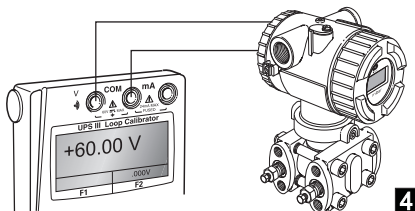

#### 5 Continuity Test

Press **mode** key and select [Continuity Test].

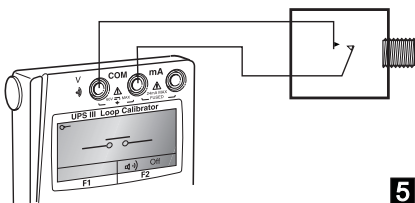

Pressing **F2** switches the audible signal on/off.



## Source Mode

The display shows the source value in mA or % value of 4 to 20 mA or 0 to 20 mA, linear or flow depending on the settings made in set-up and advanced settings.

### 6 Source mA

Press **mode** key and select [Source mA]. The calibrator supplies maximum output of: 24 mA;  $V_{max} = 60$ ; receiver input  $R_{max} = 1k\Omega$ .

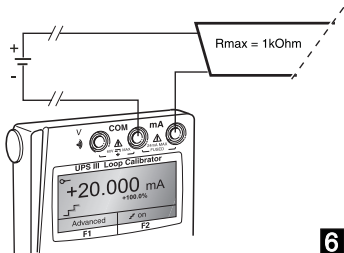

6

### 7 Source mA with 24V

Press **mode** key and select [Source mA and 24V]. The calibrator supplies maximum loop power of: 24 V and 24 mA.

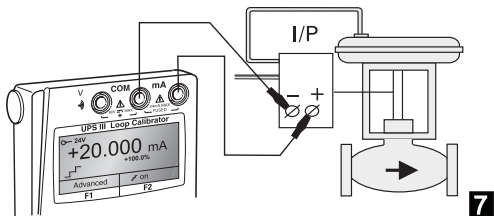

7

## Advanced Options in a Source mode

Press the **MODE** key and select mA Source or mA Source & 24V.

Use **↑** **↓** and **F2** (Enter) to select the function.

Press the **F1** key (Advanced) and the display shows:

Linear           simulates linear transmitters.

Flow             simulates flow transmitters.

Valve            simulates valve control signals.

Use **↑** **↓** and **F2** (Enter) to select the Advanced option:

### Advanced

---

|            |   |
|------------|---|
| Step       | 25% steps for linear and flow - fixed values for valve. |
| Auto-step  | The same as step with a timed step interval.            |
| Span Check | Step between 4 (or 0) mA and 20 mA.                     |
| Ramp       | Automatic ramp between 4 (or 0) mA and 20 mA.           |

---

*Note: Ramp function not available for valve selection.*

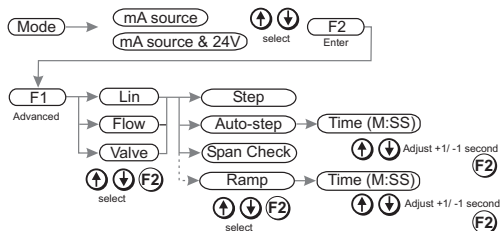

Use **F1** to quit. The display returns to the selected source mode with the advanced setting available.



## Operation of Advanced Options

Press the **(F2)** key to switch the advanced setting on and off:

e.g.  on or off

Press  or  to:

step the output up or down.

step the span check maximum or minimum

start the "ramp".

Press  then  to start:

continuous auto-step.

or

continuous ramp cycle.

## Hart® Application

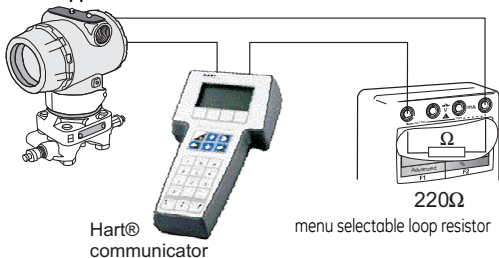

This application allows mA measure and source modes to be used through the Hart® communicator.

**blank page**

## Maintenance

- Return the loop calibrator to an authorised repair centre for any repairs, it cannot be repaired on-site.
- To keep the loop calibrator accurate a calibration check should be carried out once per year.

## Cleaning

- Clean the loop calibrator case with a moist, lint-free cloth and weak detergent.

## Battery Replacement

Only use the battery type listed on page one.

Unscrew and remove the securing screw from the battery panel.

Replace the batteries, check the polarity of the batteries. Refit and secure the battery panel.

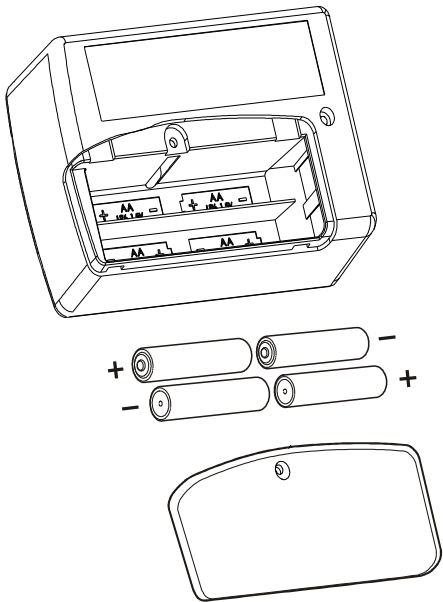

# Calibration Instructions

## General

The instrument is supplied by the manufacturer, complete with calibration certificate(s). A calibration period of 12 months is recommended. The actual calibration interval depends on instrument usage and the total measurement uncertainty acceptable for the specified application.

The UPS-III is a very precise measuring instrument and the test equipment and conditions of test must be suitable for the type of work. The calibration check and calibration adjustment should be carried out in a controlled environment by a calibration technician\*.

The manufacturer offers a comprehensive and, if required, UKAS accredited calibration service.

\* *A calibration technician must have the necessary technical knowledge, documentation, special test equipment and tools to carry out the calibration work on this equipment.*

### Calibration Equipment

The following tables give the accuracy requirements for the calibration equipment and the UPS-III.

Calibration requires a stable temperature of  $21^{\circ} \pm 1^{\circ}\text{C}$  ( $70^{\circ} \pm 2^{\circ}\text{F}$ ).

### UPS-III measure mode

**Table 1**  
**mA measure**

| Applied mA | Permitted UPS-III error (mA) | Calibrator error (mA) |
|------------|------------------------------|-----------------------|
| 0          | 0.002                        | 0                     |
| 4          | 0.002                        | 0.00014               |
| 12         | 0.002                        | 0.00030               |
| 20         | 0.002                        | 0.00046               |

**Table 2**  
**V measure**

| Applied V | Permitted UPS-III error (mV) | Calibrator error (mV) |
|-----------|------------------------------|-----------------------|
| 0         | 0.004                        | 0.00040               |
| 20        | 0.004                        | 0.00014               |
| 40        | 0.005                        | 0.00064               |
| 50        | 0.005                        | 0.00070               |

### UPS-III source mode

**Table 3**  
**mA source**

| Applied mA | Permitted UPS-III error (mA) | Calibrator error (mA) |
|------------|------------------------------|-----------------------|
| 0          | 0.002                        | 0                     |
| 4          | 0.002                        | 0.00012               |
| 12         | 0.002                        | 0.00011               |
| 20         | 0.002                        | 0.00015               |

### Calibration Check

1. Connect the UPS-III to the electrical calibrator. Switch on the electrical calibrator and allow it to thermally stabilise.
2. Switch on the UPS-III and allow the instrument to thermally stabilise.
3. Set the UPS-III to mA measure, adjust the electrical calibrator to apply the first value in the table 1. Record the reading of the UPS-III.
4. Repeat step 3 for all the values in the table 1.
5. Compare the recorded values and the applied values. If the difference is greater than the permitted error, the instrument requires a calibration adjustment.
6. Repeat this procedure for V measure (table 2) and mA source (table 3).



## Calibration Adjustment

1. Connect the UPS-III to the electrical calibrator. Switch on the electrical calibrator and allow it to thermally stabilise.

2. Switch on the UPS-III and press **F2**, within two seconds to select Calibration. Enter the access code [9410 factory setting] and allow the instrument to thermally stabilise.

3. Select the parameter required for calibration. Use the display menu to select the calibration values. After a successful calibration enter the new calibration date.

