

UPS4E

UPS4E-IS

Loop Calibrator

User Manual



About This Manual



INFORMATION Read this manual carefully before use. Keep for future reference.

This manual contains operating instructions that you must follow to make sure of safe operation and to maintain the equipment in a safe condition.

Safety

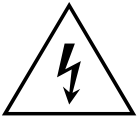

RISK OF ELECTRIC SHOCK Do not apply voltage or currents to the Calibrator that are greater than shown in the specifications.



WARNING Do not store or use the Calibrator in temperatures outside its specified range. Temperatures outside the specified range can cause damage to the batteries and Calibrator. The batteries can leak.



CAUTION Remove or replace the batteries immediately if they are exhausted. Recycle them according to your local regulations.

Check the Calibrator for damage before each use. Do not use if the Calibrator has damage.

The Calibrator is a portable instrument for use in indoor environments and temporary use in outdoor environments. It is not for permanent installation in an outdoor environment.

We have designed this equipment to be safe when operated using the procedures shown in this manual. Do not use this equipment for any other purpose than that stated, as the protection provided by the equipment may not work.

For a complete list of safety information, refer to the Quick Start and Safety Manual supplied with the Calibrator. Refer to our website for supporting documents.

www.druck.com

Extra Safety Advice for the UPS4E-IS



WARNING

Only use the USB connection for firmware update or data logging in a non-hazardous area.



Make sure the test circuit is isolated from all other power sources when using the internal 24 V supply.

Do not open the battery cover in an explosive atmosphere. Replace batteries in a non-hazardous area.

Technical Advice

Contact the manufacturer for technical advice. See rear pages for contact details.

Symbols

Symbol	Description
	This equipment meets the requirements of all relevant European safety directives. The equipment carries the CE mark.
	<p>Druck is an active participant in Europe's Waste Electrical and Electronic Equipment (WEEE) take-back initiative (directive 2012/19/EU).</p> <p>The equipment that you bought has required the extraction and use of natural resources for its production. It may contain hazardous substances that could impact health and the environment.</p> <p>In order to avoid the dissemination of those substances in our environment and to diminish the pressure on the natural resources, we encourage you to use the appropriate take-back systems. Those systems will reuse or recycle most of the materials of your end life equipment in a sound way. The crossed-out wheeled bin symbol invites you to use those systems.</p> <p>If you need more information on the collection, reuse, and recycling systems, please contact your local or regional waste administration.</p> <p>Please visit the link below for take-back instructions and more information about this initiative.</p>

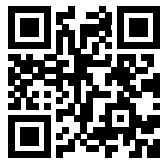

<https://druck.com/weee>

Glossary

This manual uses the following terms. Abbreviations are the same in the singular and plural.

Term	Description
CSV	Comma-separated Values
DC	Direct current
FS	Full Scale
DUT	Device Under Test
HART	Highway Addressable Remote Transducer
IS	Intrinsically Safe
mA	Milliampere
max	Maximum
min	Minute or minimum
MSC	Mass Storage Class - USB
PC	Personal Computer

Term	Description
ppm	Parts per million
PIN	Personal Identification Number
Rdg	Reading
USB	Universal Serial Bus
V	Volts
VCP	Virtual Com Port - USB
°C	Degrees Celsius
°F	Degrees Fahrenheit

What's in the Box

When you receive the product, check the box contents for these items:

- UPS4E/UPS4E-IS Calibrator.
- 4 x AA Alkaline batteries.*
- 2 m USB cable type A to C. Druck Part IO-USB-C-CABLE.
- Test leads. Druck Part 209-359.
- Quick Start Guide. Druck Part 183M0493-1.
- Certification documents

* Batteries may not be included for shipment to some countries due to local regulations.

Note: We recommend that you keep the box and packaging for future use.

Optional Items

Refer to Datasheet for any spares or accessories.

Contents

1.	Introduction and Description	1
1.1	Introduction	1
1.2	Description	2
1.3	Screen Symbols and Terms	4
1.4	Calibrator Features	6
1.4.1	UPS4E Power and USB Connection	6
1.4.2	UPS4E-IS Power and USB Connection	6
1.4.3	Battery Low Warning	7
1.4.4	USB Virtual Comm Port (VCP) and Mass Storage Class (MSC) Protocols	7
1.4.5	Current Source and Measurement	7
1.4.6	Primary and Secondary Readings	8
1.4.7	Positive and Negative Measurement	8
1.4.8	Current Range Selection	8
1.4.9	Date, Time and Calibration Date	8
1.4.10	Backlight	8
1.4.11	Auto Power Off	9
1.4.12	Selectable Internal Loop Resistor and 24 V Supply	9
1.4.13	Calibrator Information	9
1.4.14	Data Logging	9
1.4.15	Calibration	10
1.4.16	Firmware Update	10
1.5	Operation Modes and Advanced Options	10
1.5.1	Continuity Test Mode	10
1.5.2	RAMP, 'AUTO' RAMP, STEP and 'AUTO' STEP	11
1.5.3	AUTO SPAN	11
1.5.4	'SPAN' Check	12
2.	Operation	13
2.1	Power On and Off	13
2.2	Connecting by USB	13
2.3	First Use - Date and Time	14
2.4	Typical Opening Screen	15
2.5	Settings	16
2.5.1	To Open the Settings	17
2.5.2	Settings - Range and 250 ohm Internal Resistor	17
2.5.3	Setting - Data Logging	18
2.5.4	Setting - USB	18
2.5.5	Settings - Backlight and Auto Power Off	19
2.5.6	Setting - Viewing Calibrator Information	20
2.5.7	Setting - Calibration	20
2.5.8	Setting - Calibration Date	21
2.5.9	Setting - Firmware Update	21
2.5.10	Setting - Date and Time	21
2.6	Operation Modes and Advanced Options	22
2.6.1	Current Measuring Mode - External or Internal Loop Supply	23
2.6.2	Current Source Mode - External or Internal Loop Supply	24
2.6.3	Voltage Measuring and Continuity Test Modes	25
2.6.4	Advanced Options (MAN, LIN, FLOW and VALVE)	26

2.6.5	MAN (Manual) Operation	27
2.6.6	Advanced Options ('AUTO' STEP, STEP, 'AUTO' RAMP, RAMP and 'SPAN' check)	28
3.	Connections and Tasks	31
3.1	DC Current Measurement or Source - External Supply	31
3.2	DC Current Measurement or Source - Internal 24 V Supply	32
3.3	DC Current Measurement or Source - External Supply and Resistor	33
3.4	DC Current Measurement or Source - Internal 24 V Supply and Resistor	34
3.5	DC Voltage Measurement 0 - 30 VDC	35
3.6	Continuity Test	35
3.7	Data Logging	36
3.7.1	Setting - Data Log Time (Interval and Duration)	36
3.7.2	Viewing the Data Log	37
4.	Calibration Procedures	39
4.1	Before Starting	39
4.2	'ADJ' (ADJUST) function	39
4.3	ADV (ADVANCED) button polarity function	39
4.4	Calibration Notes	39
4.5	Preset Calibration Values	40
4.6	Deviation Tolerances	40
4.6.1	Current Measure	40
4.6.2	Current Source	40
4.6.3	Voltage Measure	41
4.7	Calibration Flow	42
4.8	Procedure 1: Unlock PIN for Calibration	43
4.9	Procedure 2: Current (Measure)	44
4.10	Procedure 3: Current (Source)	45
4.11	Procedure 4: Voltage (Measure)	46
4.12	Calibration Restore	47
5.	Specifications	49
6.	Maintenance	51
6.1	Cleaning	51
6.2	Installing and Changing the Batteries	51
6.3	Continuity Check	52
6.4	Updating the Firmware	52
6.4.1	Method 1.	53
6.4.2	Method 2.	53
6.5	Error Codes and Warnings	54
6.5.1	Error Codes	54
6.5.2	Warnings	54
6.6	Instrument Return	54
6.6.1	Return Goods/Material Procedure	54
6.7	Packaging for Storage or Transportation	55

1. Introduction and Description

1.1 Introduction



Figure 1-1: The UPS4E and UPS4E-IS

The Druck UPS4E and UPS4E-IS Calibrators are pocket-sized battery-operated hand-held instruments for voltage measurement and measurement and sourcing of electrical current for test and calibration of devices such as flow and pressure sensors or valves. They include a simple continuity test function and can log test data for viewing on a suitable PC. The Calibrators also have advanced current output features.

1.2 Description

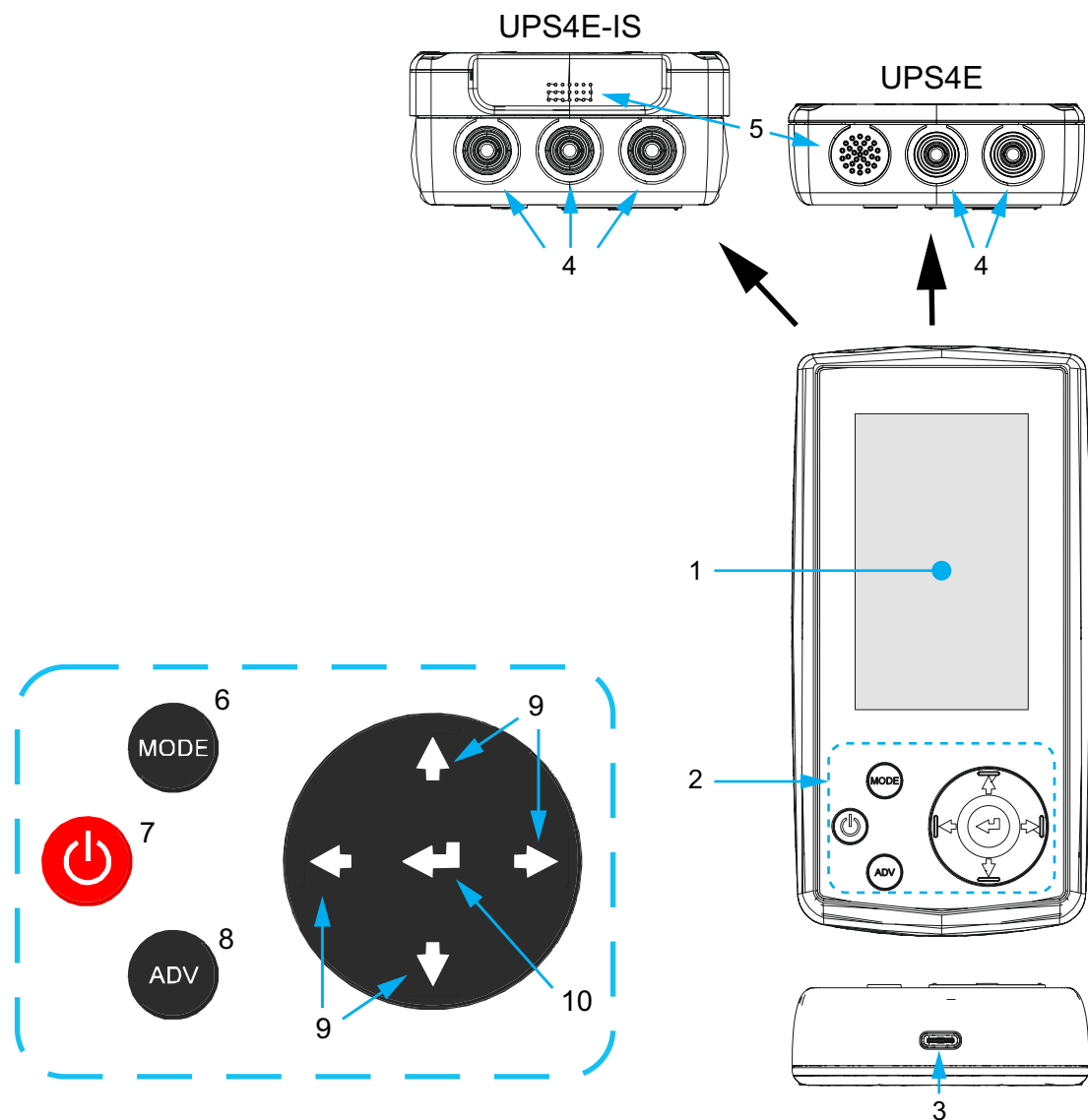

- 1 Screen
- 2 Buttons and Navigation Pad
- 3 USB Type C Connector
- 4 Red and Black Connection Sockets
- 5 Buzzer
- 6 Mode button.
- 7 Power button.
- 8 Advanced button.
- 9 Up, down, left and right Navigation Pad buttons.
- 10 Enter button.

Figure 1-2: Calibrator Primary Parts

The Calibrator has a custom segment monochrome LCD screen that shows the measured values of voltage and current. It has a Navigation Pad and three buttons for user input and operation of the Calibrator. The top of the Calibrator case has 4 mm connection sockets and a buzzer. The buzzer operates for continuity tests and to confirm some actions - for example, when energizing the Calibrator. The bottom of the case has a USB type C socket for connection to a suitable PC or USB power source (UPS4E version only).

The yellow colored UPS4E-IS is an intrinsically safe version of the blue colored UPS4E and works in the same way except for small differences needed for intrinsically safe operation. These include an additional 4 mm socket used for sourcing the internal 24 V loop power out to test

circuits. See Figure 1-3. Also, the USB socket for the IS version is only for use in data logging and firmware updates in non-hazardous areas. It does not accept power.

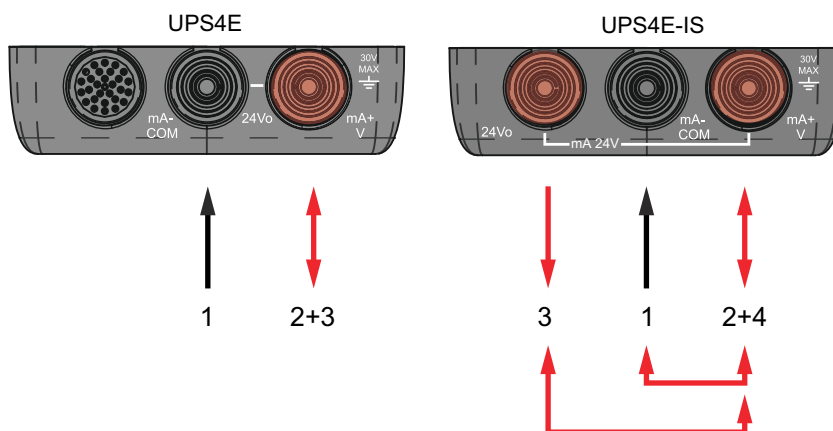

Figure 1-3: UPS4E and UPS4E-IS Sockets

- | | | | |
|---|----------------------|---|---|
| 1 | Common | 2 | mA current source or measurement
Voltage measurement |
| 3 | 24 V Loop Supply out | 4 | 24 V Loop Supply return |

Chapter 1. Introduction and Description

1.3 Screen Symbols and Terms

The display screen has pre-defined symbols and terms. You will not see all these symbols and terms at the same time. They will change, determined by how you use the Calibrator. Figure 1-4 shows the screen with all symbols and terms.

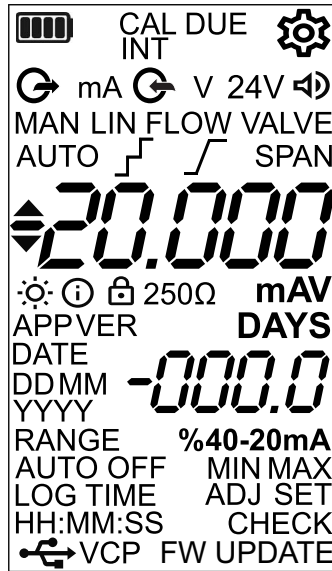









Figure 1-4: Screen Showing all Symbols and Terms

Table 1-1: Screen Symbols and Terms

Symbol/ Term	Description	Symbol/ Term	Description
	Battery level indicator - shown when using battery power. Flashes empty when the battery level is low.	DATE DDMM YYYY	Shown when setting the date. DD = Date MM = Month YYYY = Year For example: 24 10 2025
CAL	Shown when in calibration mode or setting the calibration date.	DAYS	Shows the amount of days until calibration is due.
CAL DUE	Shown when the calibration is due.		Backlight - shown when setting the backlight in the settings.
	Setting - shown when you enter the Setting menu.		Information - shown when viewing information in the settings.
INT	Shown when setting the Data log interval.	AUTO OFF	Auto Off - shown when setting the Auto Power off options.
mA	Milliampere or current measuring enabled.	%	Percentage.

Table 1-1: Screen Symbols and Terms

Symbol/ Term	Description	Symbol/ Term	Description
V	Voltage or voltage measuring enabled.	0-20mA 4 -20mA	Current Range: 0 to 20 or 4 to 20 milliamperes.
	Measure mode enabled.	RANGE	Shown when setting the 0 to 20 mA or 4 to 20 mA range.
	Source mode enabled.	MIN	Minimum.
24V	24 V loop power enabled.	MAX	Maximum.
	Continuity test enabled.	250Ω	Internal 250 ohm resistor enabled.
MAN	Manual current output enabled.	ADJ	Adjust - used in the calibration procedure.
LIN	Linear profile enabled.	SET	Used in the calibration procedure and some other settings.
FLOW	Flow profile enabled.	LOG	Enabled when setting data log and while logging data.
VALVE	Valve profile enabled.	TIME	Enabled when setting the time.
AUTO	Automatic current output enabled - used with Step and Ramp function.	CHECK	Used in the calibration process.
	Step function enabled.	HH:MM:SS	Hours, minutes and seconds. For example 16:50:32
	Ramp function enabled.	APPVER	Application version.
SPAN	Span check profile enabled.		Universal Serial Bus Port.
	Up and down indicators to show the direction of the changing primary reading. Also work as maximum and minimum indicators.	VCP	Virtual Comm Port - USB mode. The mode is MSC if VCP is not shown.
	PIN Lock - enabled when entering the PIN in restricted modes.	FW UPDATE	Firmware Update - enabled when updating the firmware.

1.4 Calibrator Features

1.4.1 UPS4E Power and USB Connection

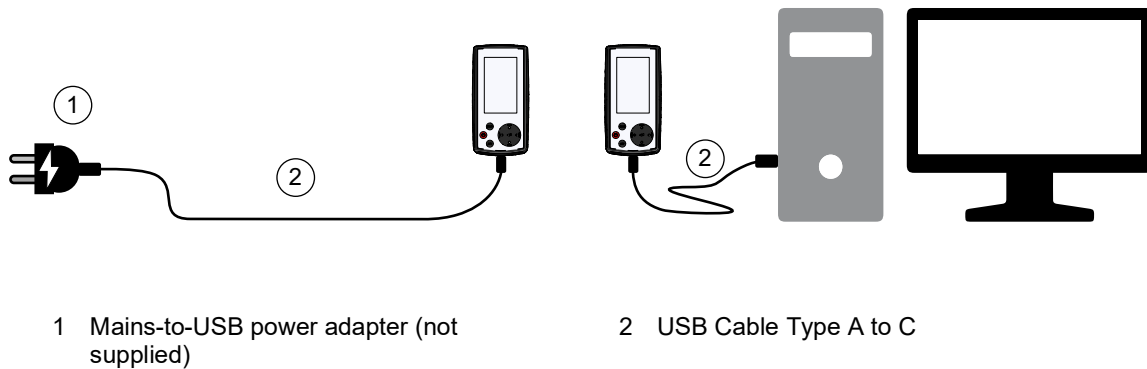

Figure 1-5: Power and USB Connection

The blue UPS4E Calibrator can be battery or USB-powered. The internal batteries supply power to the Calibrator if it is not supplied through the USB connection. When using battery power, you will see the battery level indicator. When using USB power, you will see the USB symbol in the screen and the battery symbol will go off.

You can supply power to the Calibrator through the USB connection using a suitable mains-to-USB adapter, or a connected computer. See “Specifications” for USB details.

When connected to a computer, the computer can supply power to the Calibrator and can access the internal memory of the Calibrator to open measurement data logs or update the Calibrator firmware.



INFORMATION The measurement circuits of the UPS4E are referenced to its USB socket, so if connected to a ground referenced USB supply, this may affect measurements. For optimum performance we recommend disconnecting the USB connection and using battery power only when doing measurements.

Notes:

- The USB connection does not recharge the Calibrator batteries, so do not use rechargeable batteries.
- We do not supply a mains-to-USB adapter with the Calibrator. Refer to “Specifications” on page 49 for USB power details.

1.4.2 UPS4E-IS Power and USB Connection

The yellow UPS4E-IS Calibrator can only be powered by its batteries. The USB socket is only for connection to a suitable PC for data logging and firmware update in non-hazardous areas. It will not accept power from an external source.

1.4.3 Battery Low Warning



The Calibrator shows a warning when the battery drops to a low level. In this case, the battery symbol will flash.



CAUTION Remove or replace exhausted batteries immediately. Recycle them according to your local regulations.

1.4.4 USB Virtual Comm Port (VCP) and Mass Storage Class (MSC) Protocols

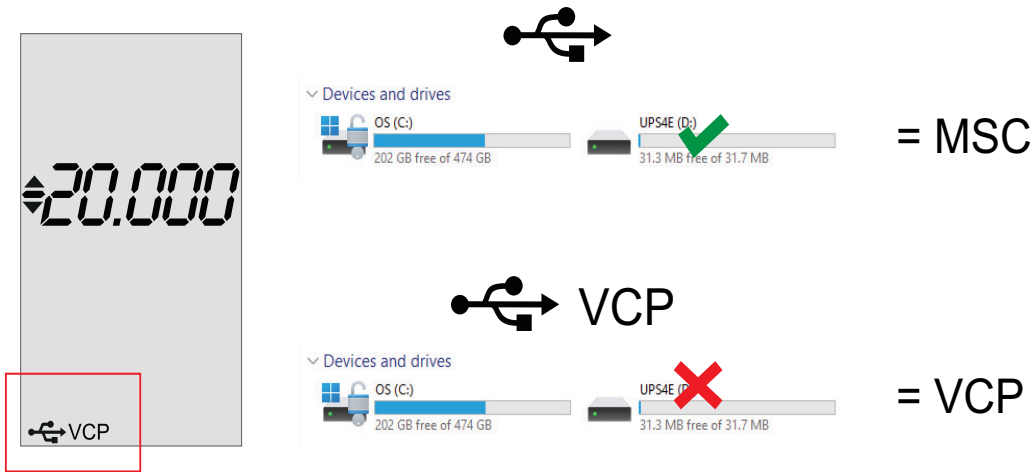

Figure 1-6: MSC and VCP mode

The USB connection can work in a choice of two USB protocols. VCP is the default mode. It sets the USB socket to work as a communications port for direct communications with your PC to make the initial connection. MSC mode lets your PC see the internal memory of the Calibrator as a storage device, so you may see and download data log files or transfer files.

1.4.5 Current Source and Measurement

The Calibrator can work as a current source to control **and** measure the current in a loop containing a device such as a valve, with or without an external supply. It will also work as a measurement-only instrument where external devices control the loop supply current.

1.4.6 Primary and Secondary Readings

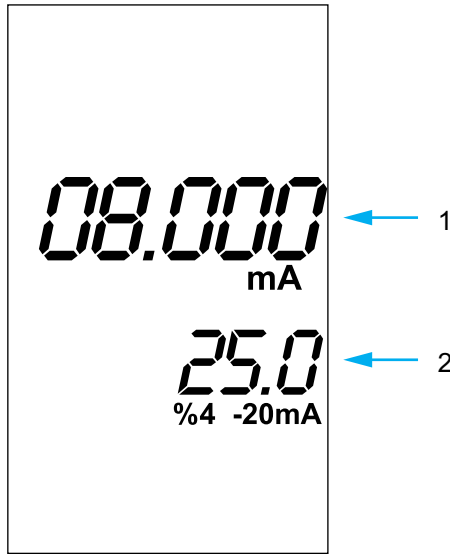

Figure 1-7: Two Readings

The Calibrator has two sets of readings; the primary reading (1) and the secondary reading (2). The primary reading shows the measured value in units of milliamperes or volts. It can also show text for some operations, settings and calibration. The primary reading can flash for few seconds during some measurements until the Calibrator measurement circuits determine that the value has stabilized or the value is out of range or that the loop is open. The secondary reading shows the measured value as a percentage of the range you have selected. This is also true for reversed (negative) readings. The calibration procedures use the secondary reading when setting calibration values.

Note: The advanced options can affect the secondary reading percentage value relationship with the measured value shown in the primary reading. For example 8 mA = 50% with FLOW selected or 8 mA = 25% with LIN selected in the 4-20 mA range.

1.4.7 Positive and Negative Measurement

The Calibrator has red (positive) and black (negative) connections to show polarity of connection, but it will measure in both positive and negative polarity. The primary and secondary readings will show a negative symbol for reverse polarity readings.

Note: Current sourcing is only in positive polarity.

1.4.8 Current Range Selection

The Calibrator has two current range options: 4-20 mA or 0-20 mA.

1.4.9 Date, Time and Calibration Date

You can set the current date and time in the Calibrator and the calibration date. The Calibrator can then calculate how many days until calibration is due. The screen will show '**CAL DUE**' when calibration is due.

1.4.10 Backlight



Figure 1-8: Backlight Symbol

The screen of the Calibrator has a backlight for use in dark areas. The backlight has three settings, **ON**, **OFF** or **AUTO**. See “Settings - Backlight and Auto Power Off” on page 19 for more detail.

Note: The backlight for the yellow UPS4E-IS does not operate in continuity mode and will turn off when doing a firmware update.

1.4.11 Auto Power Off

To save battery energy, this feature de-energizes the Calibrator after ten minutes of no button pushes.

Note: The Calibrator disables the **Auto Power Off** feature when you use data logging or when using USB power.

1.4.12 Selectable Internal Loop Resistor and 24 V Supply

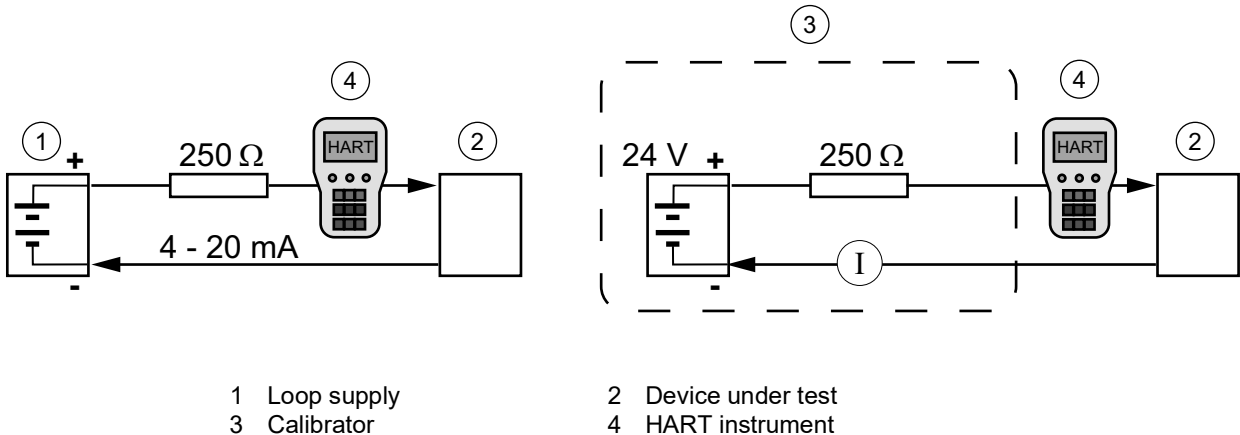

Figure 1-9: Loop Resistor and 24 V Supply

In a process control or measurement loop, a resistor of between 230 and 600 ohm is necessary for communications to work correctly with HART instruments.

The Calibrator has an internal 24 V supply and a nominal 250 ohm loop resistance in series that you can enable or disable. The Calibrator can then work as a loop supply, resistor and measuring instrument, so an external resistor and loop supply is not necessary. You can disable one or both of these features if you have an external voltage source and resistor.

Note: You must enable the internal 24 V supply or have an external loop supply for the Calibrator to control current.

1.4.13 Calibrator Information



Figure 1-10: Information Symbol

Use the Calibrator **Settings** to show important Calibrator information such as the firmware version (APP VER) or battery voltage of the Calibrator. See “Settings” for more details.

1.4.14 Data Logging

The Calibrator can log the data from your tests at set intervals and durations. See “Data Logging” on page 36 for more details.

Chapter 1. Introduction and Description

1.4.15 Calibration

The Calibrator has a PIN-protected procedure for checking and adjusting its calibration using suitable external calibration equipment. See “Calibration Procedures” on page 39 for more details.

1.4.16 Firmware Update

The Calibrator has a PIN-protected procedure for upgrading its firmware using a suitable PC and the USB cable supplied with the Calibrator. See “Updating the Firmware” on page 52.

1.5 Operation Modes and Advanced Options

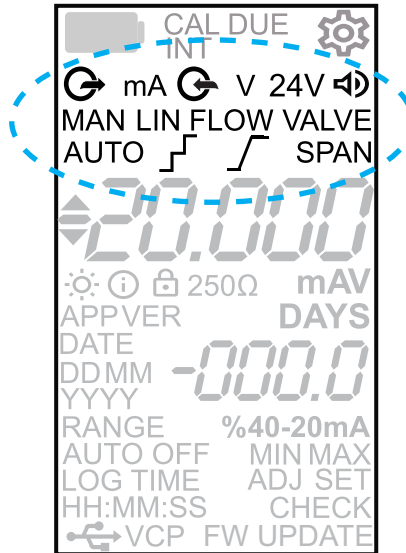

Figure 1-11: Mode and Advanced Option Symbols

The upper part of the screen shows the operation mode and advanced option symbols. You can select basic operation modes of measure or source, with or without the internal 24 V supply enabled. The advanced options give different ways to change the source current. See “Operation Modes and Advanced Options” on page 22 for more details.

1.5.1 Continuity Test Mode



Figure 1-12: Continuity Symbol

The Calibrator can work as a simple continuity tester. When connected to a device under test (DUT) the Calibrator will operate its buzzer if the DUT has a resistance of less than approximately 100 ohms.

The primary reading will show **oPEn** or **Short** circuit.

1.5.1.1 Manual, Linear, Flow and Valve Profiles

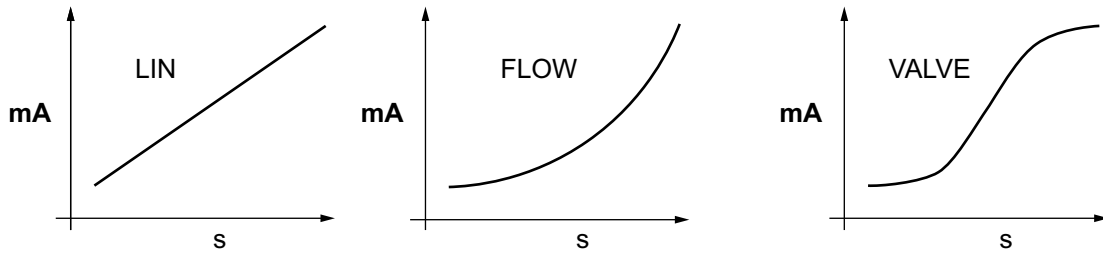

Figure 1-13: Linear, Flow and Valve Profiles (s = time)

You can select different profiles for the Calibrator:

- ‘MAN’ - Manual, where you manually set the loop current to any value.
- ‘LIN’ - Linear, where the loop current changes in a linear way to simulate linear transmitters.
- ‘FLOW’ and ‘VALVE’ - where the loop current changes in a non-linear way to simulate flow transmitter and valve control signals.

See “Specifications” on page 49 for the preset values.

Note: These options can affect the secondary reading percentage value relationship with the measured value shown in the primary reading, even in measure mode. For example 8 mA = 50% with ‘FLOW’ selected or 8 mA = 25% with ‘LIN’ selected in the 4-20 mA range.

1.5.2 RAMP, ‘AUTO’ RAMP, STEP and ‘AUTO’ STEP



Figure 1-14: RAMP, AUTO RAMP, STEP and AUTO STEP functions

The **RAMP** symbol shows that the output current will gradually change in value from minimum to maximum of the selected range over a specified time that you can set. You start the ramp using the **Navigation Pad** buttons. ‘**AUTO**’ **RAMP** automatically cycles the output current over the specified time. With **RAMP** selected, the Calibrator calculates the values and rate of change, based on the specified time.

The **STEP** symbol shows that the output current will change in steps of preset values from minimum to maximum of the selected range over a specified time that you can set. You change the steps using the **Navigation Pad** buttons. ‘**AUTO**’ **STEP** automatically cycles the output current in preset values over the specified time.

See “Advanced Options (‘AUTO’ STEP, STEP, ‘AUTO’ RAMP, RAMP and ‘SPAN’ check)” on page 28 for more details.

See “Specifications” on page 49 for the preset step values.

Note: The ‘VALVE’ profile option does not have the **RAMP** function.

1.5.3 AUTO SPAN

The AUTO SPAN option lets you select a number of cycles, time (minutes and seconds) and steps (percentage values) over which the calibrator will change the current from minimum to maximum and back to minimum

Note: This option is only available for the **VALVE** profile.

Chapter 1. Introduction and Description

See “Advanced Options (‘AUTO’ STEP, STEP, ‘AUTO’ RAMP, RAMP and ‘SPAN’ check)” on page 28 for more details.

1.5.4 ‘SPAN’ Check

This option lets you manually set the current source output directly from minimum to maximum of the range and back using the buttons of the **Navigation Pad**. This will do a full span check.

See “Advanced Options (‘AUTO’ STEP, STEP, ‘AUTO’ RAMP, RAMP and ‘SPAN’ check)” on page 28 for more details.

2. Operation

This chapter shows how to set and operate the features of the Calibrator.

2.1 Power On and Off



Figure 2-1: To Energize the Calibrator

1. To energize the Calibrator, push the **Power** button until the screen operates. It will normally operate the buzzer, show the UPS4E text then show a typical opening screen. See Figure 2-3. If this is the first use of the Calibrator after fitting new batteries, it will ask you to enter the date and time. See “First Use - Date and Time”.
2. To de-energize the Calibrator, push the **Power** button for more than two seconds and release. The screen will go off.

2.2 Connecting by USB

1. Use the USB cable supplied with the Calibrator. Connect its smaller USB C plug into the USB connection on the bottom of the Calibrator. See Figure 1-5 on page 6.
2. Connect the USB A plug into a USB type A socket of your computer, or into the output socket of a suitable mains to USB adapter. See “Specifications” for power details.
3. Energize the PC or USB adapter and the Calibrator.

2.3 First Use - Date and Time

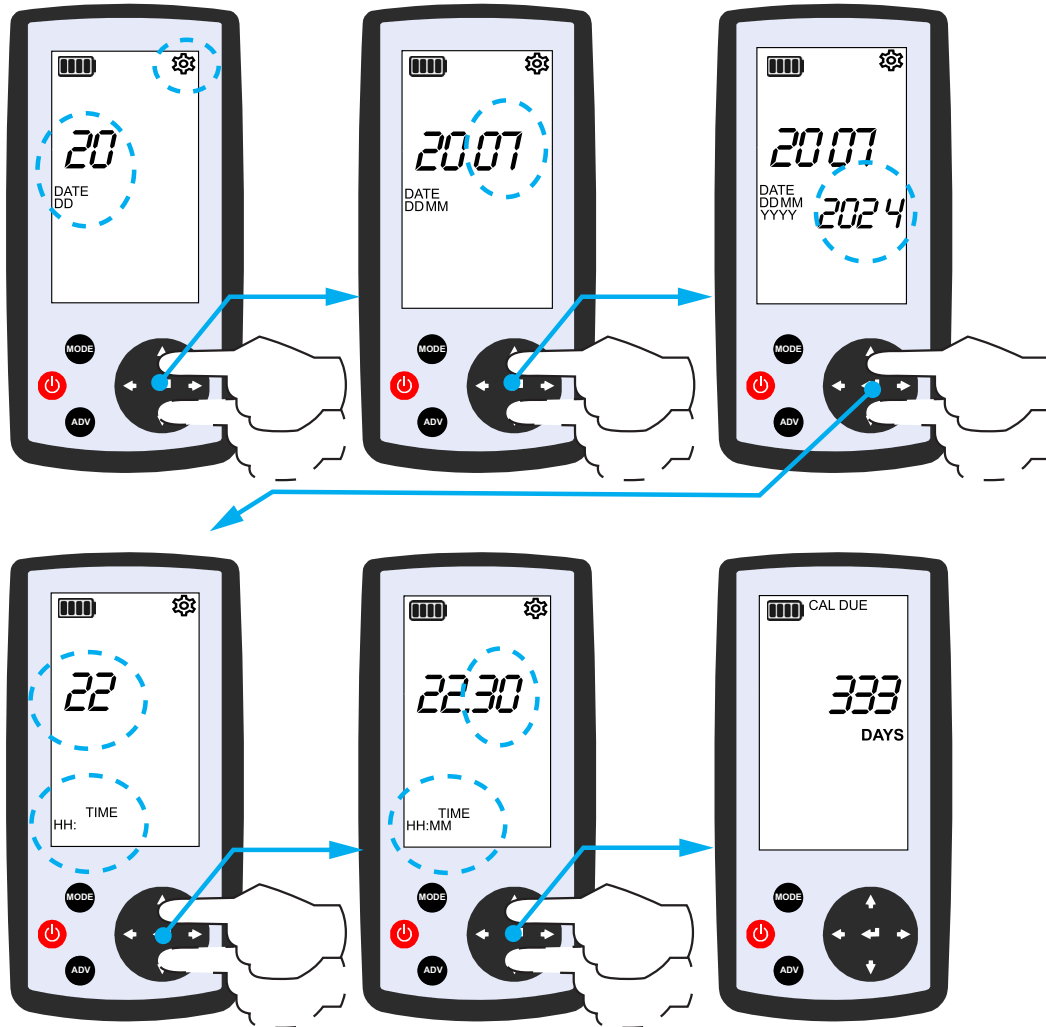

Figure 2-2: Set Date and Time

When you first energize a Calibrator after fitting new batteries (or the batteries have been removed for longer than approximately seven minutes), the Calibrator will automatically enter the **Settings** to ask you to set the current date and time. It can then compare this with the calibration date to calculate and show how many days until calibration. The default date will be the build date set in the factory. You can adjust the calibration date in the **Settings**. Refer to “Setting - Calibration Date” on page 21.



1. The screen will show the **Settings** symbol and flash the **DATE** day (**DD**). Use the **Navigation** up and down buttons to change the date.
2. Push the **Enter** button to accept the date.
3. The screen will sequentially show the month (**MM**), year (**YYYY**), **TIME** hours (**HH**) and minutes (**MM**). At each step, use the **Navigation Pad** up and down buttons to change the values. Push the **Enter** button to accept the values and move onto the next value.
4. Finally, the screen will show the amount of '**DAYS**' until the calibration is due (**CAL DUE**), based on the calibration date. See “Setting - Calibration Date” on page 21.

2.4 Typical Opening Screen

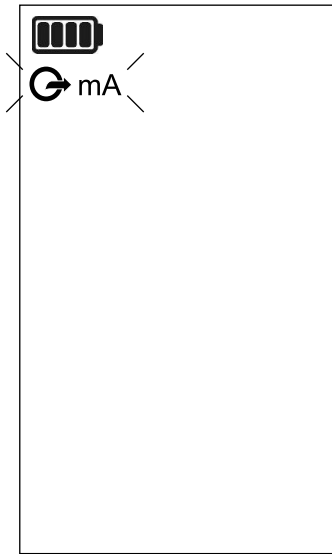

Figure 2-3: Typical Opening Screen

After you have set the date and time, the Calibrator will show an opening screen that flashes the mA and source symbols, asking you to select an operation mode such as mA source or measure. It will show the same opening screen each time you energize it.

2.5 Settings

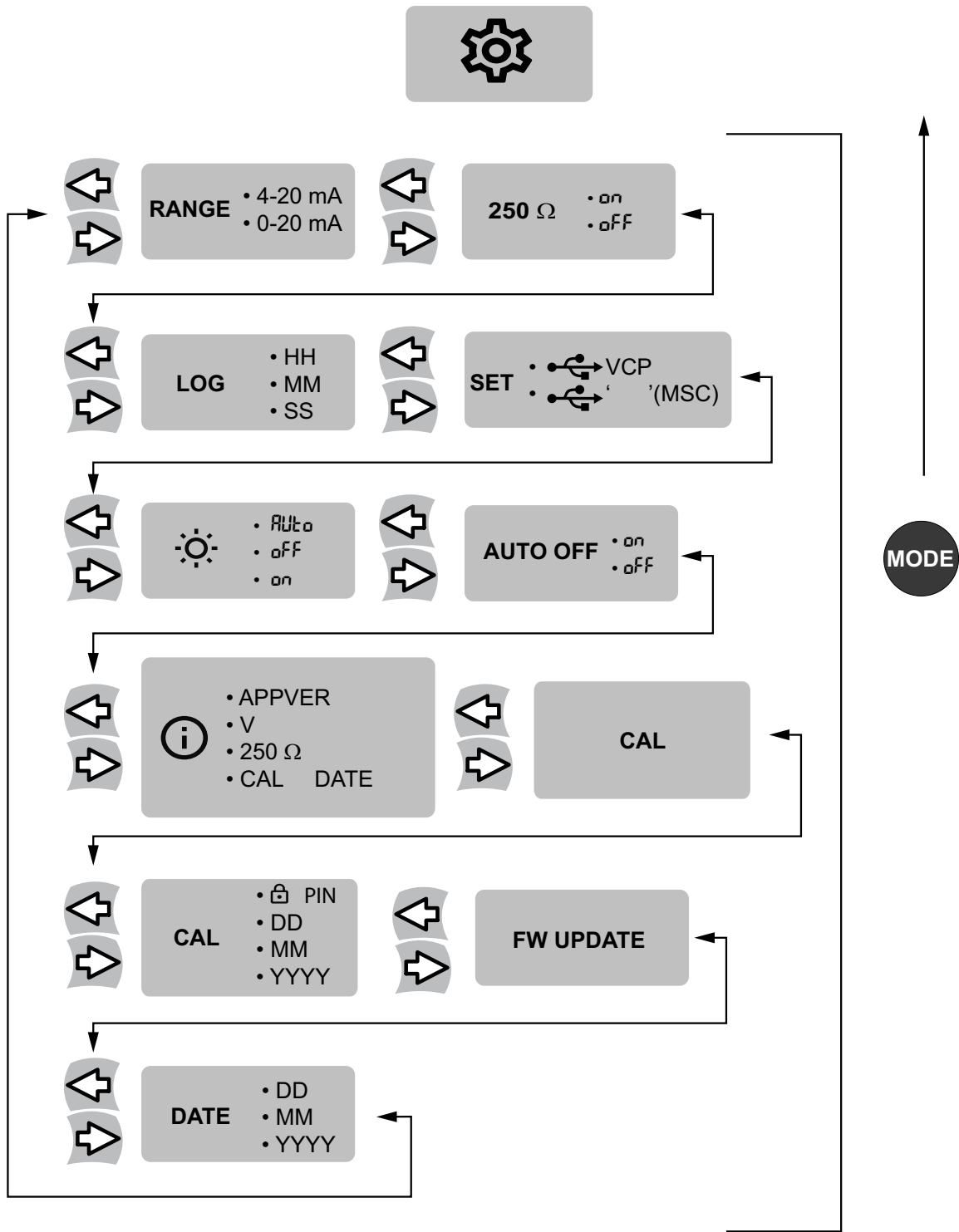



Figure 2-4: Settings Options Flow

The Calibrator has settings that you can change, such as the backlight or measuring range. When you open the settings, the screen shows the **Settings**  symbol in the top right.

2.5.1 To Open the Settings

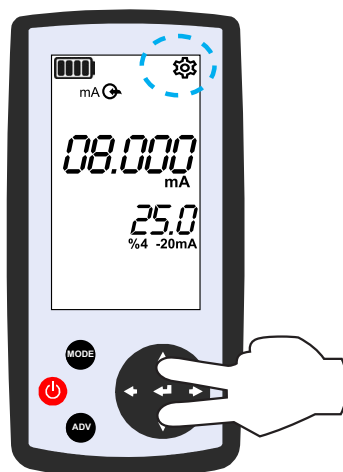

Figure 2-5: To Open the Settings

1. To open the settings, push both the up and down **Navigation Pad** buttons together. The screen will show the **Settings** symbol.
2. Use the **Navigation Pad** buttons to go through the settings and make any changes as shown in the following pages.
3. Push the '**MODE**' button at any time to escape the **Settings** or to return to the opening screen.

2.5.2 Settings - Range and 250 ohm Internal Resistor

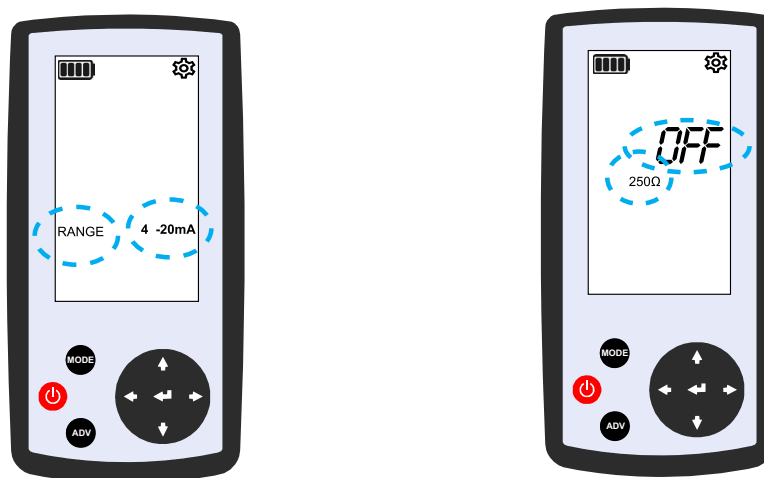

Figure 2-6: Settings - Range and 250 ohm Resistor

1. Open the **Settings**.
2. The screen will show '**RANGE**'. If not, then push the right hand **Navigation Pad** button until the screen shows '**RANGE**'. It will flash.
3. Push the **Enter** button to accept that you are to select the range.
4. Push the up and down **Navigation Pad** buttons to select **0-20 mA** or **4-20 mA**.
5. Push the **Enter** button to save the range setting.
6. Push the right hand **Navigation Pad** button until the screen shows **250 Ω**.

Chapter 2. Operation

7. Push the **Enter** button to accept that you are to select the resistor.
8. Push the up and down **Navigation Pad** buttons to select '**ON**' or '**OFF**'.
9. Push the **Enter** button to save the setting.

2.5.3 Setting - Data Logging

Refer to Section 3.7 on page 36.

2.5.4 Setting - USB

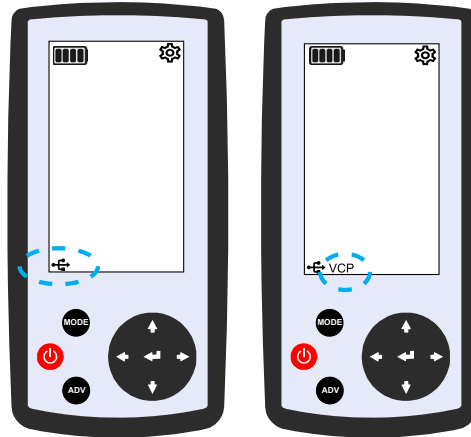



Figure 2-7: Settings - USB

1. Open the **Settings**.
2. Push the right hand **Navigation Pad** button until the screen shows '**SET**' and the **USB** symbol . It will flash.
3. Push the **Enter** button to accept that you are to set the USB mode.
4. Push the up or down **Navigation Pad** buttons to select **VCP** on or off. If **VCP** is not shown, then the mode is **MSC**. **VCP** is the default mode.
5. Push the **Enter** button to accept your changes.

Note: **VCP** is the default USB mode, so the Calibrator will return to **VCP** mode if you:

- de-energize the Calibrator
- press the **MODE** button
- use the up and down **Navigation Pad** buttons

When using **MSC** mode, do not press any further buttons until you have finished using this mode.

2.5.5 Settings - Backlight and Auto Power Off

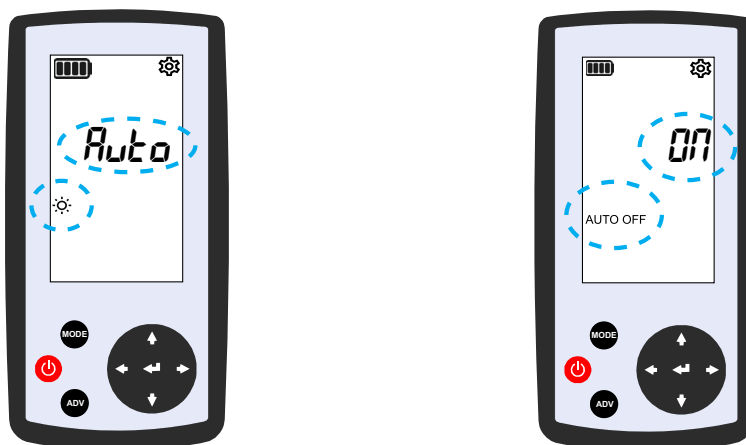

Figure 2-8: Settings - Backlight and Auto Power Off

1. Open the **Settings**.
2. Push the right hand **Navigation** button until the screen shows the backlight symbol. It will flash.
3. Push the **Enter** button to accept that you are to set the backlight.
4. Push the up and down **Navigation** buttons to select '**Auto**', '**ON**' or '**OFF**'.
 - **ON** - the backlight is on at all times while the Calibrator is energized
 - **OFF** - the backlight is never on
 - **AUTO** - the backlight remains on for ten seconds after the last button has been pushed while the Calibrator is energized
5. Push the **Enter** button to save the Backlight setting.
6. Push the right hand **Navigation** button until the screen shows '**AUTO OFF**'. It will flash.
7. Push the **Enter** button to accept that you are to set the auto power off.
8. Push the up and down **Navigation** buttons to select '**ON**' or '**OFF**'.
9. Push the **Enter** button to save the setting.

2.5.6 Setting - Viewing Calibrator Information

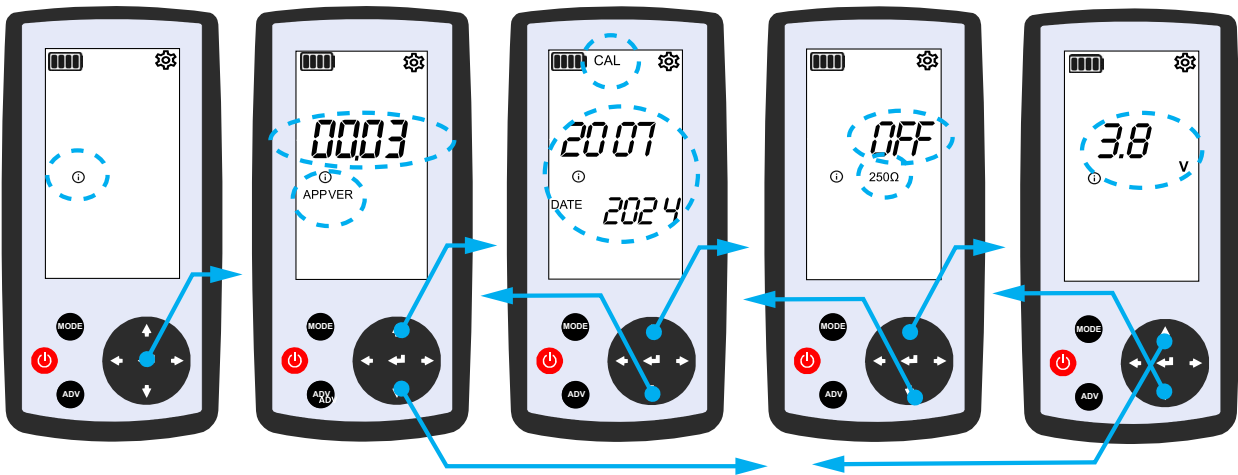

Figure 2-9: Settings - Calibrator Information

1. Open the **Settings**.
2. Push the right hand **Navigation** button until the screen shows the Information symbol (i) . It will flash.
3. Push the **Enter** button to accept that you are to view information.
4. Push the up and down **Navigation** buttons to select the information that you need to see, for example:
 - Software version APPVER
 - Battery voltage V
 - 250 ohm resistor on or off
 - Calibration date
5. Select the '**MODE**' button to return to normal operation.

2.5.7 Setting - Calibration

Refer to Section 4 on page 39.

2.5.8 Setting - Calibration Date

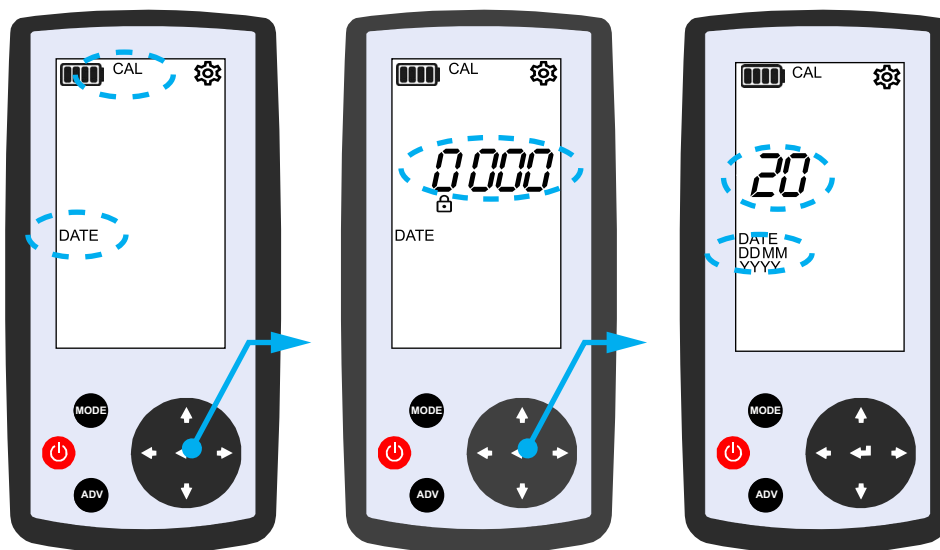

Figure 2-10: Settings - Calibration Date

1. Open the **Settings**.
2. Push the right hand **Navigation Pad** button until the screen shows the 'DATE' and 'CAL' symbols. They will flash.
3. Push the **Enter** button to accept that you are to set the calibration date.
4. The screen shows the PIN symbol to let you know that you must enter the four digit PIN 4321 to continue to set the calibration date. Use the left and right **Navigation Pad** buttons to select each digit and use the up and down **Navigation Pad** buttons to change the number of each digit. Then push **Enter**.
5. Push the left and right **Navigation Pad** buttons to select day (**DD**), month (**MM**) or year (**YYYY**). They will flash.
6. Push the up and down **Navigation Pad** buttons to change the value of the day, month or year.
7. Push the **Enter** button each time to accept your changes.
8. The Calibrator will now use this date to calculate the days until the calibration is due.

2.5.9 Setting - Firmware Update

Refer to "Updating the Firmware" on page 52.

2.5.10 Setting - Date and Time

Refer to "First Use - Date and Time" on page 14.

2.6 Operation Modes and Advanced Options

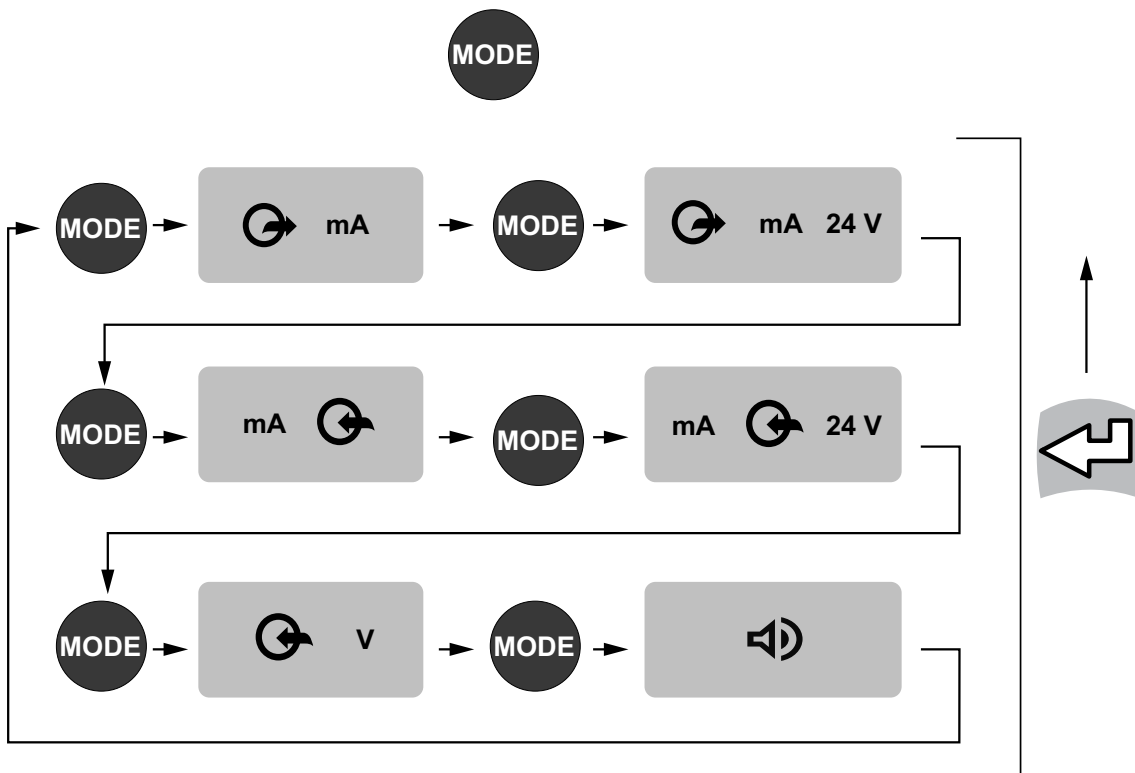

Figure 2-11: MODE Options Flow

You use the '**MODE**' button to select the operation modes of the Calibrator. For example, current or voltage measuring or current sourcing. Select the **Enter** button to accept the mode and escape to the Advanced Options.

2.6.1 Current Measuring Mode - External or Internal Loop Supply

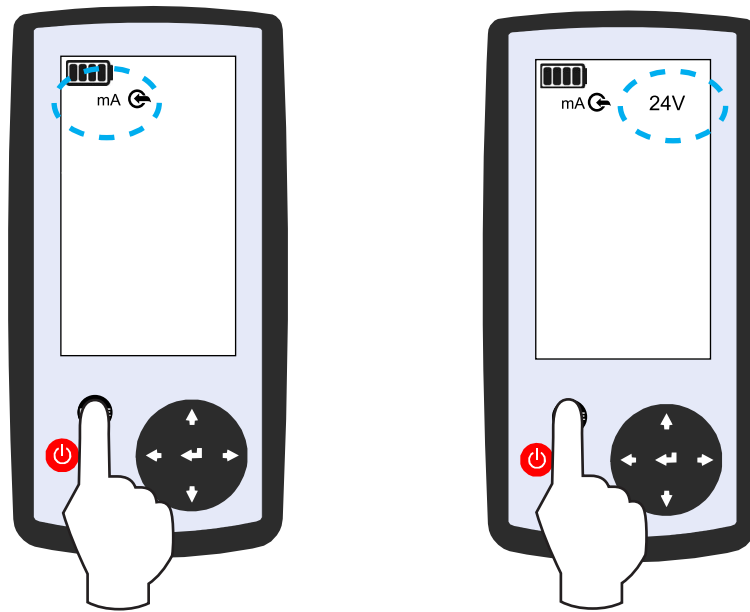

Figure 2-12: Current Measure Mode

This is for use when the external device under test controls the loop current.

1. Push the '**MODE**' button until the screen shows the current symbol **mA** and the **measure** mode symbol.
2. For internal loop supply, push the '**MODE**' button again until the screen shows the **24 V** symbol.
3. Push the **Enter** button to accept your changes.
4. Now select the Advanced Options of '**LIN**' or '**FLOW**' to change the way the secondary reading shows percentage value as necessary. See "Advanced Options (MAN, LIN, FLOW and VALVE)" on page 26.

2.6.2 Current Source Mode - External or Internal Loop Supply

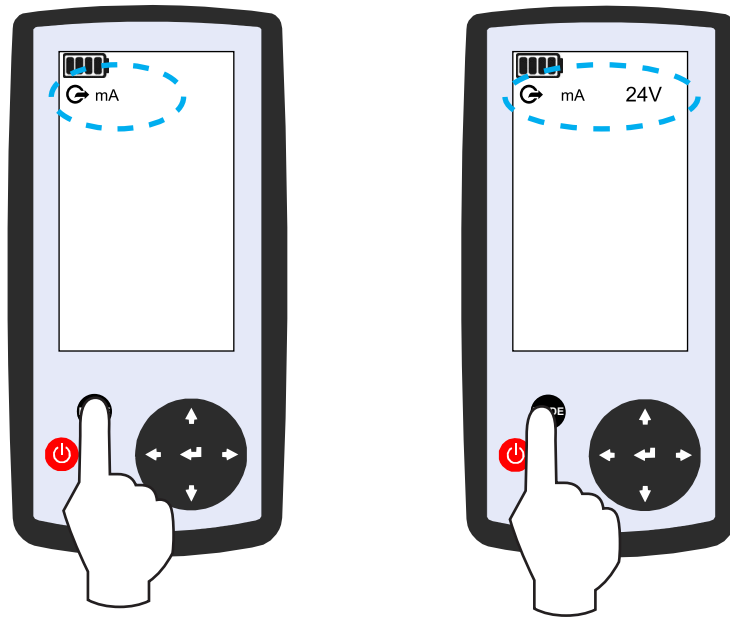

Figure 2-13: Current Source Mode

This is for use when the Calibrator controls the loop current.

1. Push the '**MODE**' button until the screen shows the **source** mode symbol and the current symbol **mA**.
2. For internal loop supply, push the '**MODE**' button again until the screen shows the **24 V** symbol.
3. Push the **Enter** button to accept your changes.
4. Now select the Advanced Options. See "Advanced Options (MAN, LIN, FLOW and VALVE)" on page 26.

2.6.3 Voltage Measuring and Continuity Test Modes

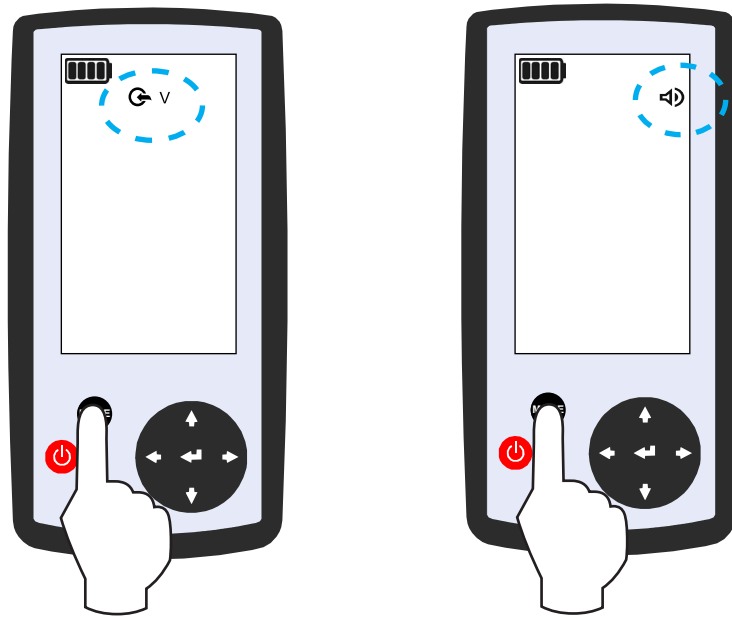

Figure 2-14: Voltage Measure and Continuity Modes

1. Push the '**MODE**' button until the screen shows the **measure** mode symbol and the voltage symbol **V**.
2. Push the **Enter** button to accept your changes.
3. To change to continuity test, select the '**MODE**' button again until the screen shows the Continuity Buzzer symbol.
4. Push the **Enter** button to accept your changes. There are no Advanced Options for these modes.

2.6.4 Advanced Options (MAN, LIN, FLOW and VALVE)

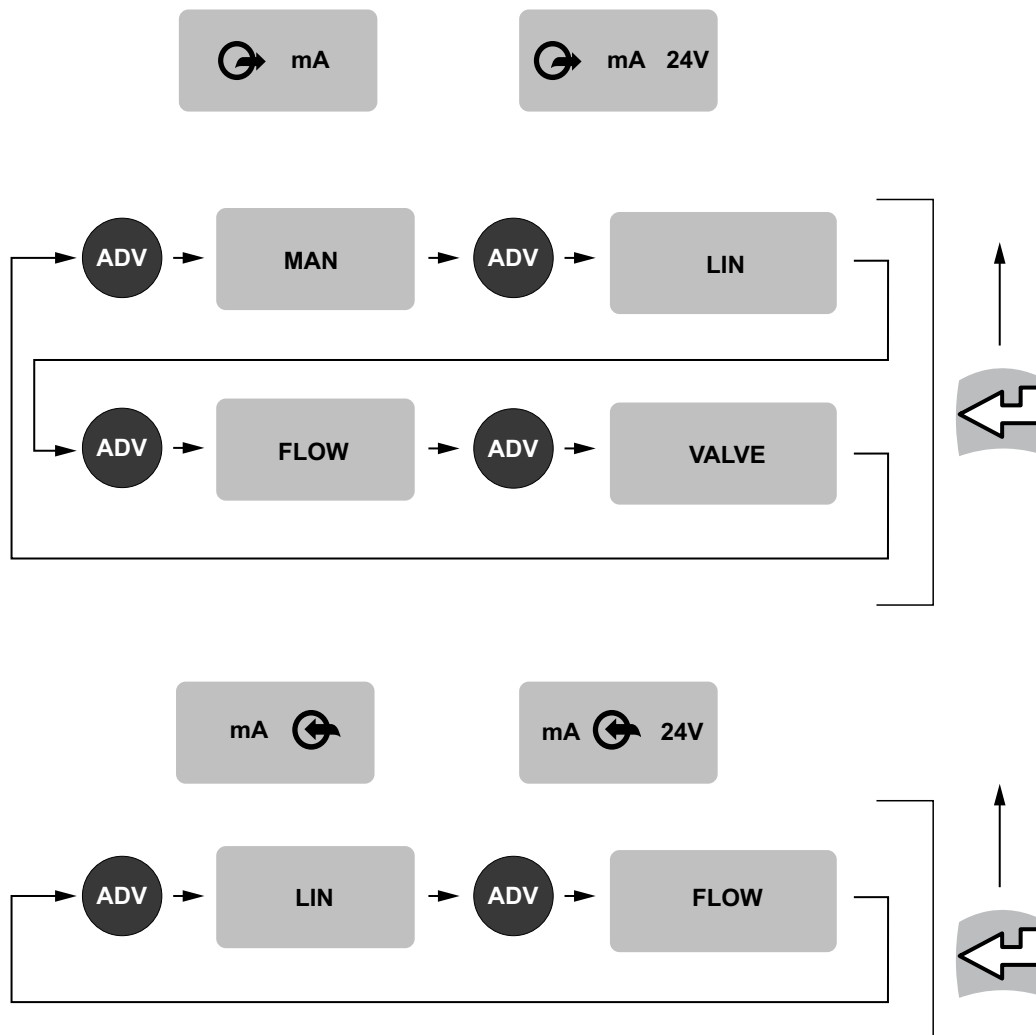

Figure 2-15: Advanced Options MAN, LIN, FLOW and VALVE

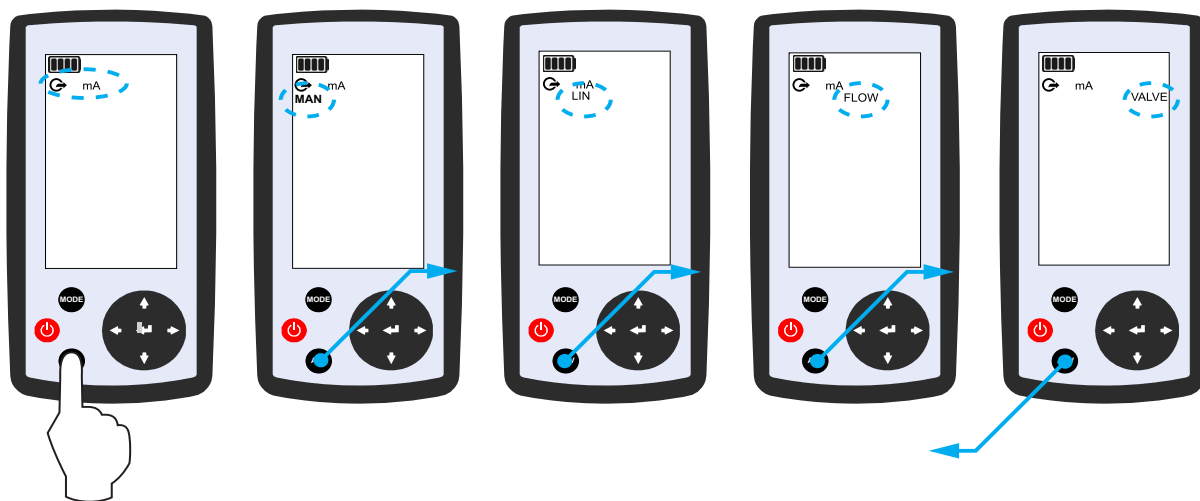

Figure 2-16: Selecting Advanced Options

From a current **source** mode:

1. Push the **ADV** button.'
2. Use the **ADV** (Advanced) button to go through the profile options of '**MAN**', '**LIN**', '**FLOW**' or '**VALVE**'. This will change how the Calibrator controls the output current and how the secondary reading shows the percentage.
3. Push the **Enter** button to accept your selection.

From a current **measure** mode:

1. Push the **ADV** button.
2. Use the **ADV** (Advanced) button to go through the profile options of '**LIN**' or '**FLOW**'. This will change how the secondary reading shows the percentage.
3. Push the **Enter** button to accept your selection.

2.6.5 MAN (Manual) Operation

1. Select the '**MAN**' profile.
2. You can now manually enter a value to output. Use the **Navigation Pad** up, down, left and right buttons to select each digit in the primary reading and change it's value.
3. Push the **Enter** button to accept the value. The secondary reading will show the value as a percentage of range.
4. The Calibrator can now control the loop current at the value you have set. Remember that you must select the internal 24 V supply or have an external supply in the loop. The primary reading will flash if there is no loop current.

Note: In current **source**, **MAN** (Manual) operation can work with linear and '**FLOW**' profiles. With just the word '**MAN**' showing, the manual operation is linear, but it is not necessary to show the LIN symbol on the Calibrator. To select '**MAN**' with '**FLOW**', after you have selected '**FLOW**' mode, push the '**ADV**' button again until the Calibrator shows '**MAN**', then push **Enter**. The Calibrator will now show '**MAN**' and '**FLOW**'. The Calibrator is now in manual operation but with the '**FLOW**' profile.

2.6.6 Advanced Options ('AUTO' STEP, STEP, 'AUTO' RAMP, RAMP and 'SPAN' check)

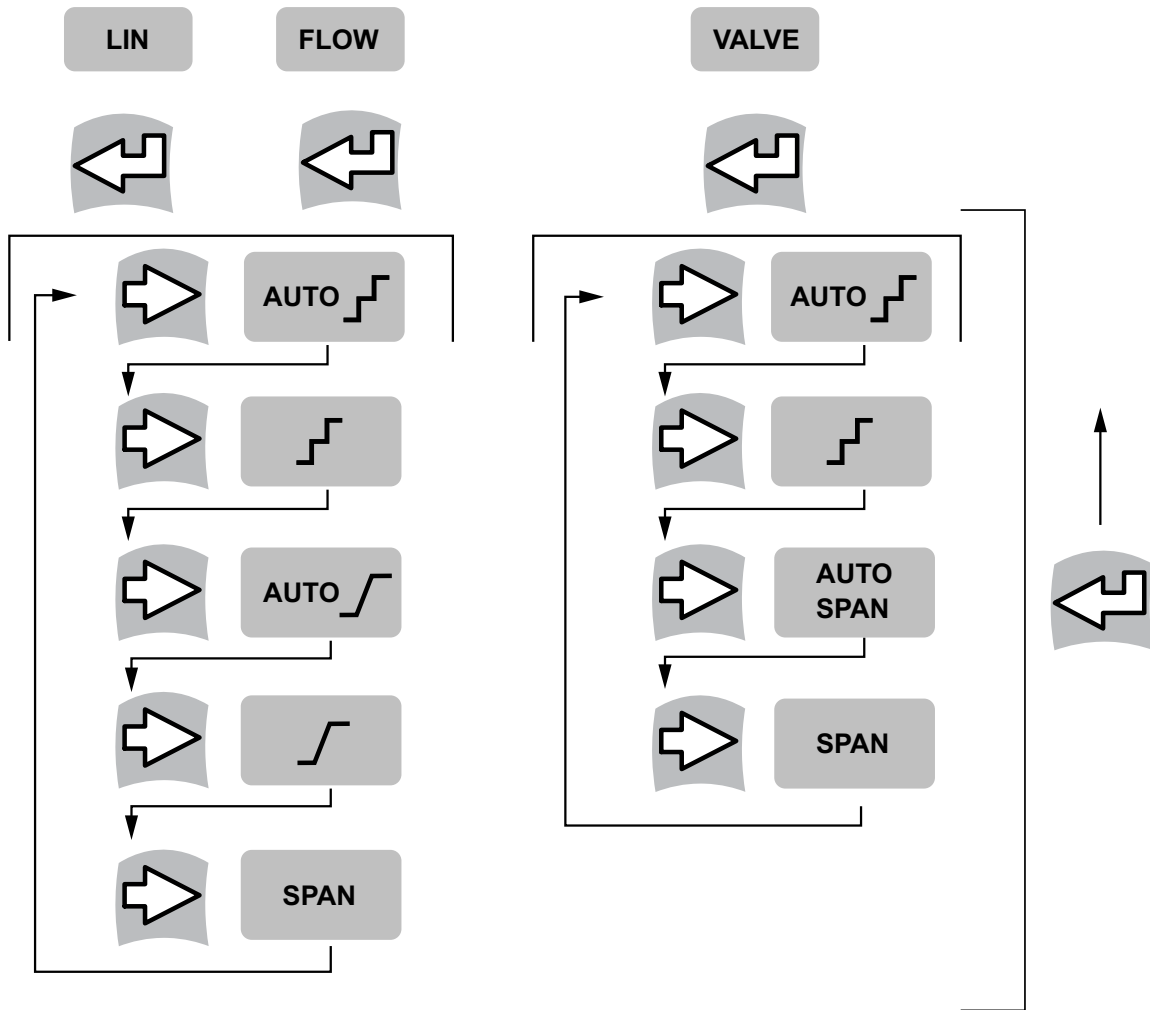

Figure 2-17: Advanced Options - 'AUTO' STEP, STEP, 'AUTO' RAMP, RAMP, AUTO SPAN and 'SPAN' check

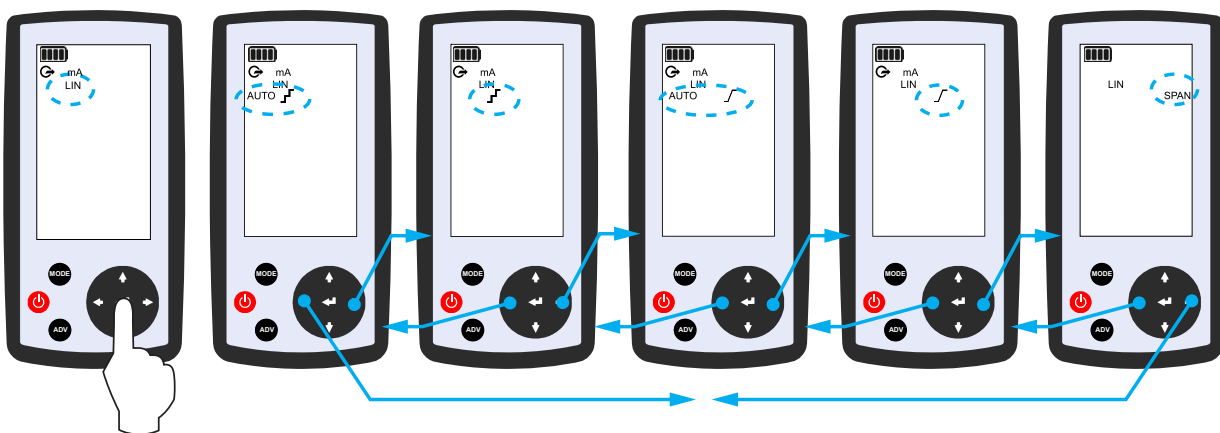

Figure 2-18: Selecting Advanced Options

1. From a current **source** profile option of '**LIN**', '**FLOW**' or '**VALVE**' profile, push the **Enter** button.
2. Use the **Navigation** pad left and right buttons to go through the options of '**AUTO**' **STEP**, '**STEP**', '**AUTO**' **RAMP**, '**RAMP**', '**AUTO**' **SPAN** and '**SPAN**' **check**.
3. Push the **Enter** button to accept your selection.

Note: The '**VALVE**' profile option does not have the **Ramp** function. Only the '**VALVE**' profile has the **AUTO SPAN** option.

- For the '**AUTO**' **STEP**, '**RAMP**' and '**AUTO**' **RAMP** functions you must then use the **Navigation Pad** buttons to set the time interval, followed by the **Enter** button to accept your selection.
- For the '**AUTO**' **STEP** functions, the output will now change through the preset steps over the time interval you have set. It will continue the cycle until you de-energize the Calibrator or change mode. You may push the **Enter** button to pause the function. Push again to restart.
- For the '**AUTO**' **RAMP** function, the output will now change over the time interval you have set. It will continue the cycle until you de-energize the Calibrator or change mode. You may push the **Enter** button to pause the function. Push again to restart.
- In **STEP** mode, use the **Navigation Pad** up and down buttons to manually step through the preset output current values.
- In **RAMP** mode, use the **Navigation Pad** up and down buttons to manually start the ramp which will automatically go up or down through the calculated output current values.
- For the **AUTO SPAN** function, use the **Navigation Pad** buttons to select the amount of cycles, time and steps for the test. Cycles (CyC) is the number of cycles from minimum to maximum and back to minimum. The time is the amount of dwell time between each step change. The step (StEp) is a percentage value. For example, a step of 25% for a 4 to 20 mA range will produce values of 4, 8, 12, 16 and 20, and the same in reverse. A step of 30% will produce 4, 8.8, 13.6, 18.4, 20, then 15.2, 10.4, 5.6 and 4. Push the **Enter** button to start the test. The primary reading shows the value. The secondary reading shows the number of cycles remaining. The Calibrator shows '**End**' when the function has completed.
- In '**SPAN**' **check** mode, use the **Navigation Pad** up and down buttons to change directly from the maximum to minimum output current values and back.

Notes:

- When using AUTO current source functions for cycle intervals of over ten minutes, disable the Auto Power Off feature. See "Settings - Backlight and Auto Power Off" on page 19. This prevents the calibrator from turning off automatically during the cycle.
- Remember that you must either select the internal 24 V supply or have an external supply in the loop for the Calibrator to work.
- See "Specifications" on page 49 for '**LIN**', '**FLOW**' and '**VALVE**' preset values of current.

3. Connections and Tasks

The section gives typical details of how to connect the Calibrator for a given task. Before starting, read the safety precautions contained in the 'Safety & Quick Start Guide'.

3.1 DC Current Measurement or Source - External Supply



CAUTION External supplies must be no more than 30 VDC.

Set the Calibrator correctly to measure or source as necessary before connecting it to a device under test.

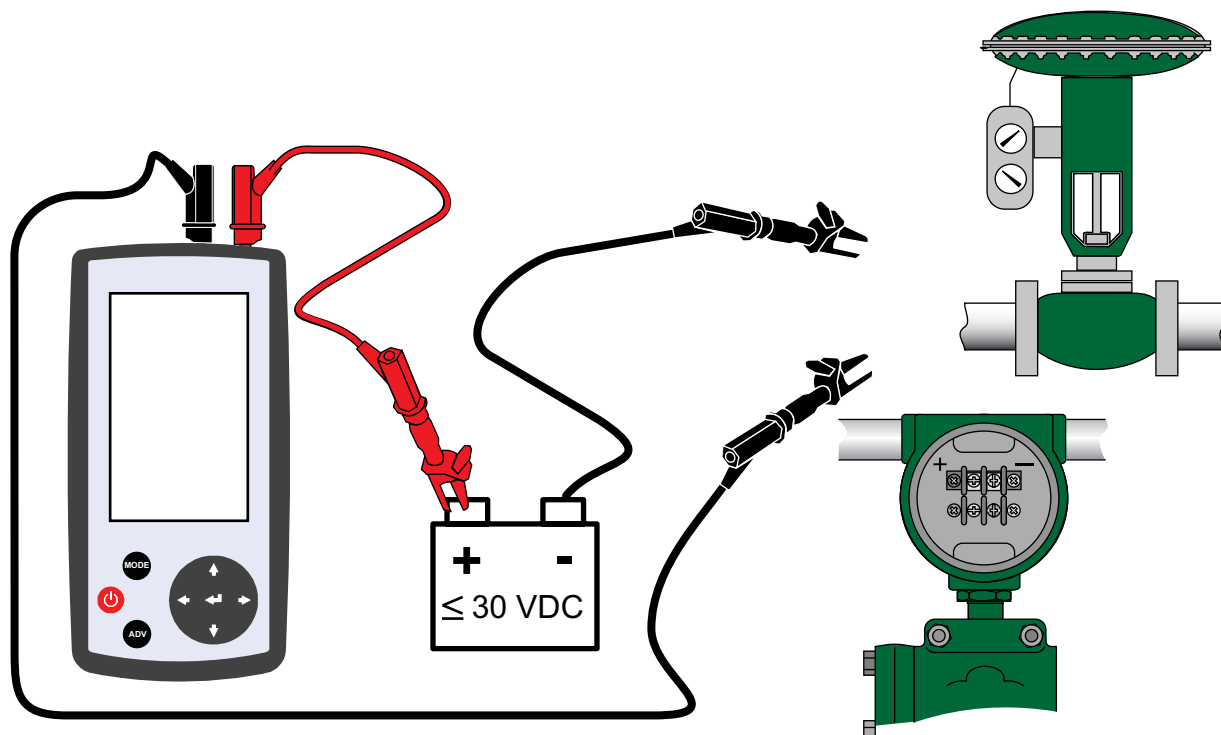

Figure 3-1: DC Current Measurement or Source - External Supply

1. Set the necessary **RANGE** in the Calibrator. For example 4-20 mA.
2. Set the Calibrator to **measure** or **source** current. **Do not** enable the internal 24 V loop power.
3. Select the Advanced Options you need, for example 'LIN' output, and 'FLOW'.
4. Connect the cables to the unit under test and the external supply as shown.
5. The primary reading will show you the loop current.
6. If sourcing current, use the **Navigation Pad** buttons to change the source current, then press the **Enter** button.
7. The primary reading can flash for a few seconds until the Calibrator measurement circuits determine that the value has stabilized.

3.2 DC Current Measurement or Source - Internal 24 V Supply

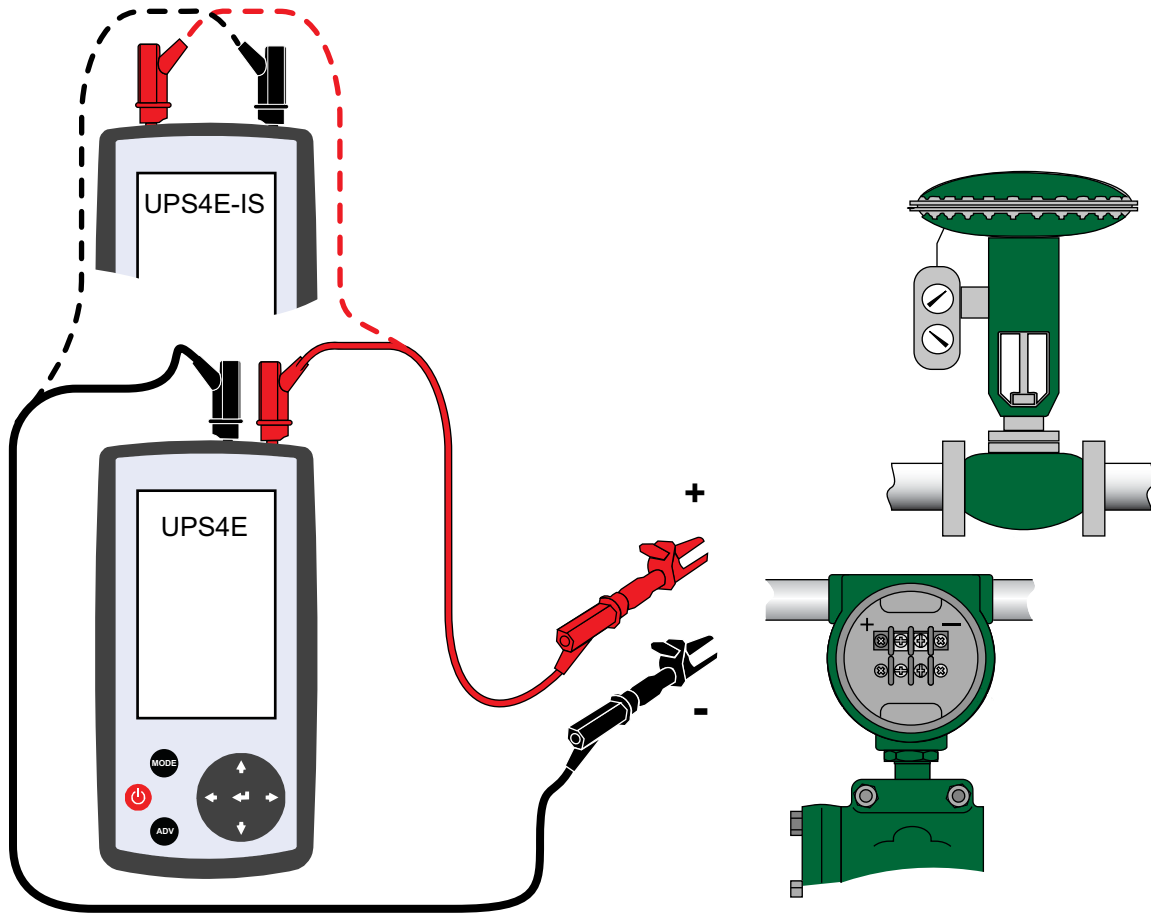

Figure 3-2: DC Current Measurement or source - Internal 24 V Supply

1. Set the necessary **RANGE** in the Calibrator. For example 4-20 mA.
2. Set the Calibrator to **measure** or **source** current with internal 24 V loop power.
3. Select the Advanced Options you need, for example '**LIN**' output, and '**FLOW**'.
4. Connect the cables to the unit under test as shown. Note the different connections for the UPS4E-IS when using the internal loop supply.
5. The primary reading will show you the loop current.
6. If sourcing current, use the **Navigation Pad** buttons to change the source current, then press the **Enter** button.
7. The primary reading can flash for a few seconds until the Calibrator measurement circuits determine that the value has stabilized.

3.3 DC Current Measurement or Source - External Supply and Resistor



CAUTION External supplies must be no more than 30 VDC.

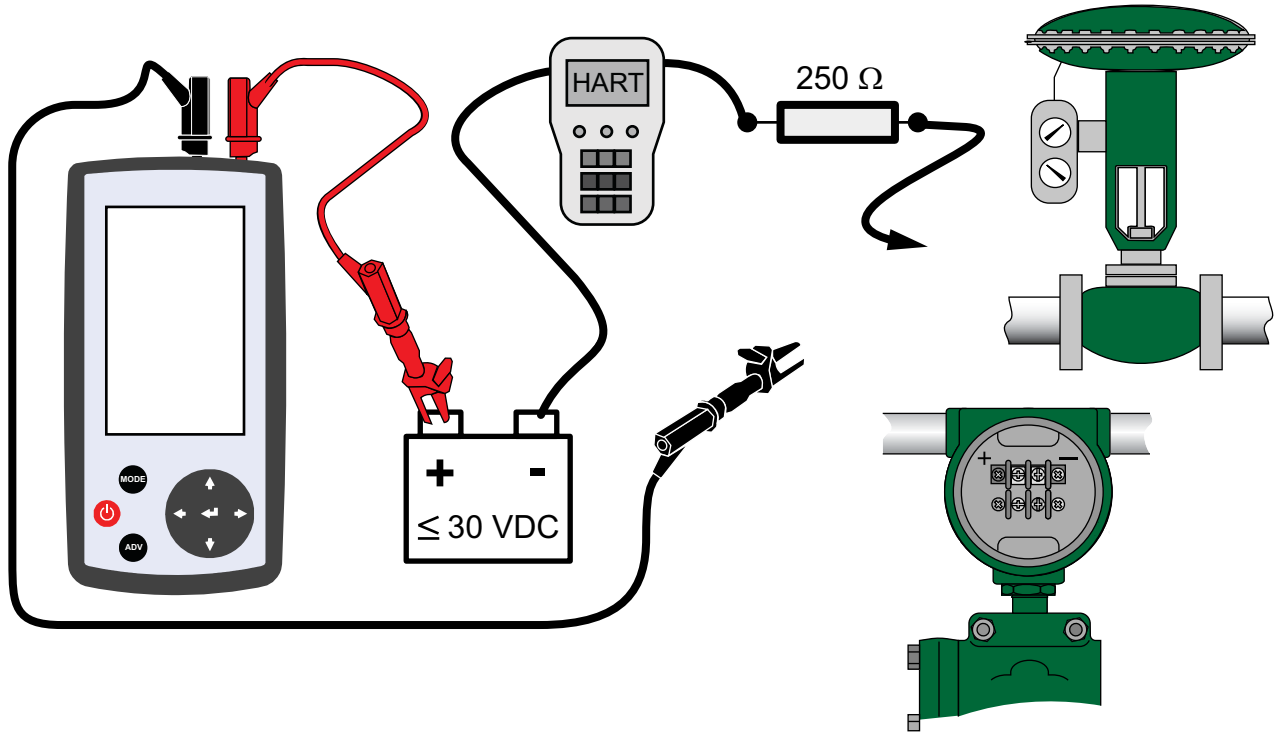

Figure 3-3: DC Current Measurement - External Supply and Resistor

1. Set the necessary **RANGE** in the Calibrator. For example 4-20 mA.
2. Set the Calibrator to **measure** or **source** current with an external supply. **Do not** enable the internal 24 V source or 250 ohm resistor.
3. Select the Advanced Options you need, for example '**LIN**' output, and '**FLOW**'.
4. Connect the cables to the unit under test, the HART device and the external source as shown.
5. The primary reading will show you the loop current.
6. If sourcing current, use the **Navigation Pad** buttons to change the source current, then press the **Enter** button.
7. The primary reading can flash for a few seconds until the Calibrator measurement circuits determine that the value has stabilized.

3.4 DC Current Measurement or Source - Internal 24 V Supply and Resistor

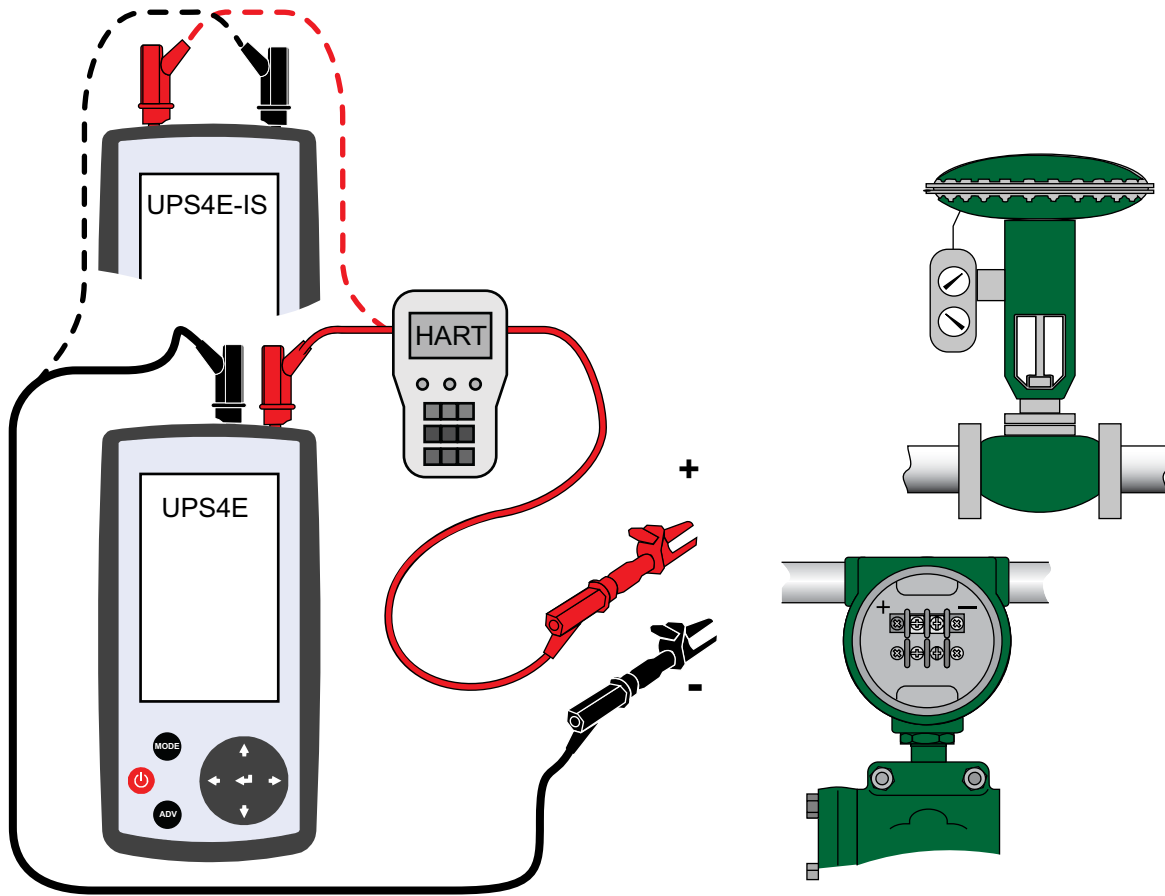

Figure 3-4: DC Current Measurement or Source - Internal 24 V Supply

1. Set the Calibrator to **measure** or **source** current with internal 24 V supply and 250 ohm resistor.
2. Set the necessary **RANGE** in the Calibrator. For example 4-20 mA.
3. Select the Advanced Options you need, for example '**MAN**' or '**LIN**' output, and '**AUTO**' **STEP** or '**SPAN**'.
4. Connect the cables to the unit under test and the HART device (if used) as shown. Note the different connections for the UPS4E-IS when using the internal loop supply.
5. The primary reading will show you the loop current.
6. If sourcing current, use the **Navigation Pad** buttons to change the source current, then press the **Enter** button.
7. The primary reading can flash for a few seconds until the Calibrator measurement circuits determine that the value has stabilized.

3.5 DC Voltage Measurement 0 - 30 VDC



CAUTION Voltage sources must be no more than 30 VDC.

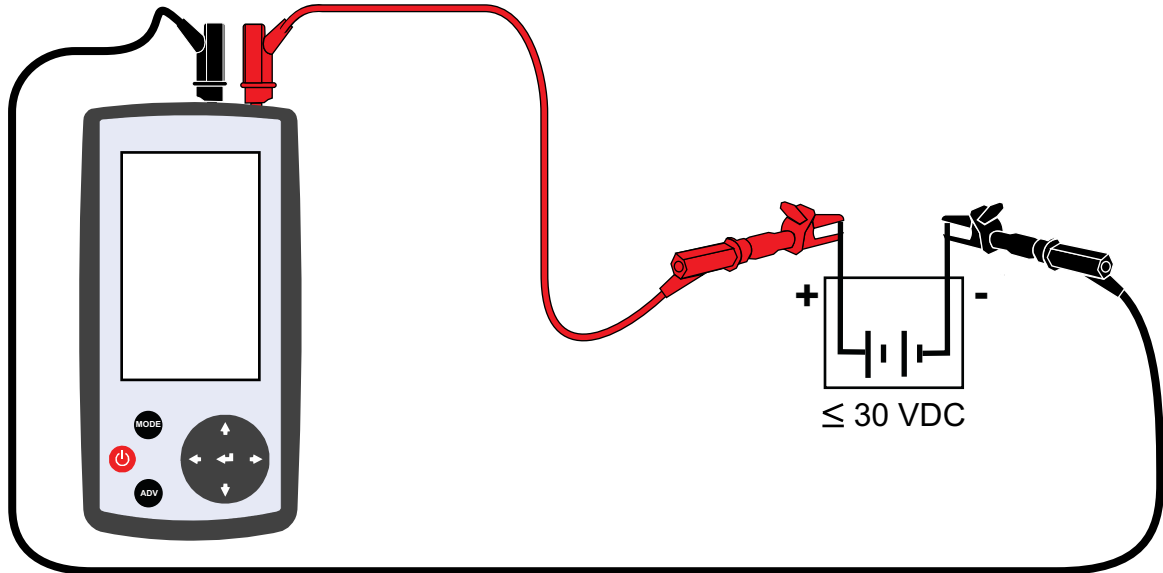

Figure 3-5: DC Voltage Measurement

1. Set the Calibrator to **measure** voltage. See “Voltage Measuring and Continuity Test Modes” on page 25.
2. Connect the cables to the voltage supply as shown.
3. The primary reading shows the measured voltage.

3.6 Continuity Test

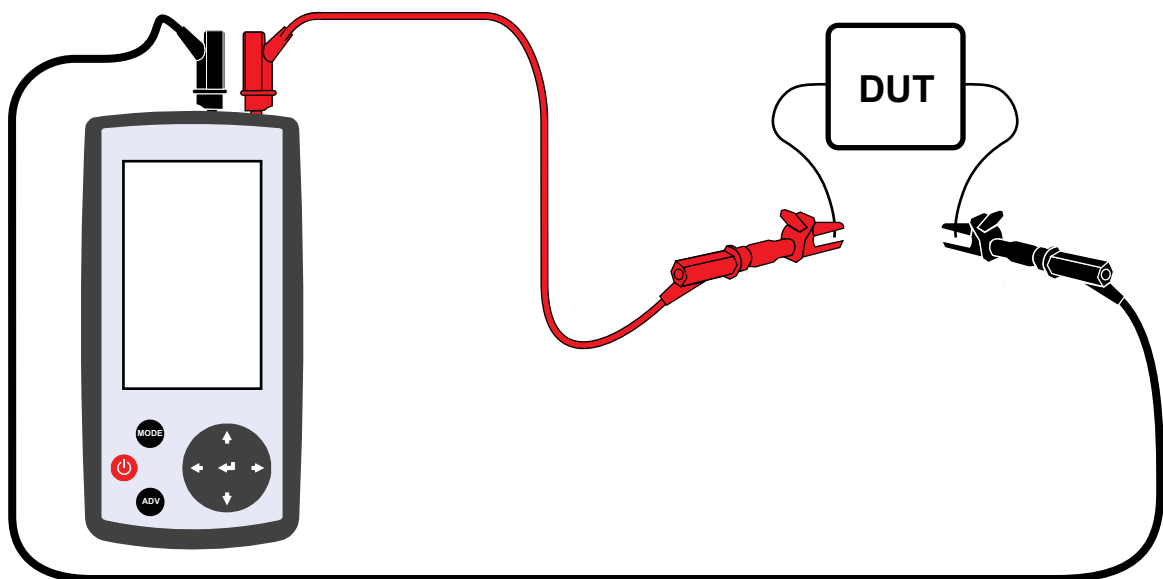

Figure 3-6: Continuity Test

Chapter 3. Connections and Tasks

1. Set the Calibrator to Continuity test. See “Voltage Measuring and Continuity Test Modes” on page 25.
2. Connect the cables to the device under test (DUT) as shown.
3. If the DUT has a resistance of less than 100 ohms, the Calibrator buzzer will operate and the primary reading will show ‘**Short**’ (short-circuit). If the DUT has a resistance higher than 1000 ohms, the buzzer will not operate and the primary reading will show ‘**Open**’ (open circuit).

3.7 Data Logging

Use the Calibrator **Settings** to log the data from your tests until you manually stop the logging or de-energize the Calibrator. The Calibrator will store the data internally in *.CSV file format, so you can then load it to a suitable PC for inspection. To read the log files, your computer must have a suitable spreadsheet application installed, such as Microsoft Excel.

Note: The Calibrator disables the **Auto Power Off** feature when you use data logging.

3.7.1 Setting - Data Log Time (Interval and Duration)

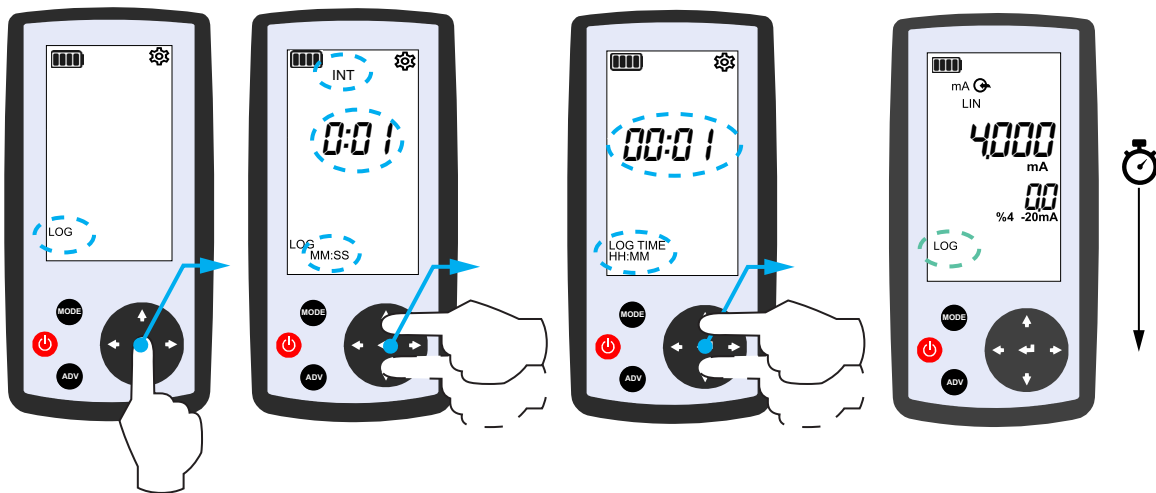

1. Set the Calibrator into the measurement or source mode you wish to use and connect it to the test loop.

Note: You cannot change the operation mode while the Calibrator logs data. You must stop and restart the data log if you need to change the operation mode.

2. Open the **Settings**.
3. Push the right hand **Navigation** button until the screen shows **LOG**. It will flash.
4. Push the **Enter** button to accept that you are to set the log interval and duration.
5. You first set the **interval**. The screen shows **INT**. Push the left and right **Navigation** buttons to select minutes (MM) and seconds (SS). Push the up and down **Navigation** buttons to change the digits for minutes or seconds.
6. Push the **Enter** button to save the interval time.
7. Now set the **duration**. Push the left and right **Navigation** buttons to select minutes (MM) and hours (HH). Push the up and down **Navigation** buttons to change the minutes or hours.
8. Push the **Enter** button to save the interval and duration and start the Data Logging. The Calibrator will return to the opening screen.
9. The **LOG** symbol will flash and the Calibrator will automatically log your measurements at the interval and duration of time that you have set. You can manually stop it by pressing the **MODE** or **ADV** buttons or de-energize the Calibrator.

3.7.2 Viewing the Data Log

1. Disconnect the Calibrator from the test loop.
2. Use the cable supplied to connect the Calibrator to a suitable PC.
3. In the Calibrator **Settings**, set the USB connection to MSC mode. See “Setting - USB” on page 18.
4. The PC will see the Calibrator internal memory as a mass storage device.
5. Use a file explorer application on the PC to examine the Calibrator internal memory for the **DataLog** folder that contains the files.

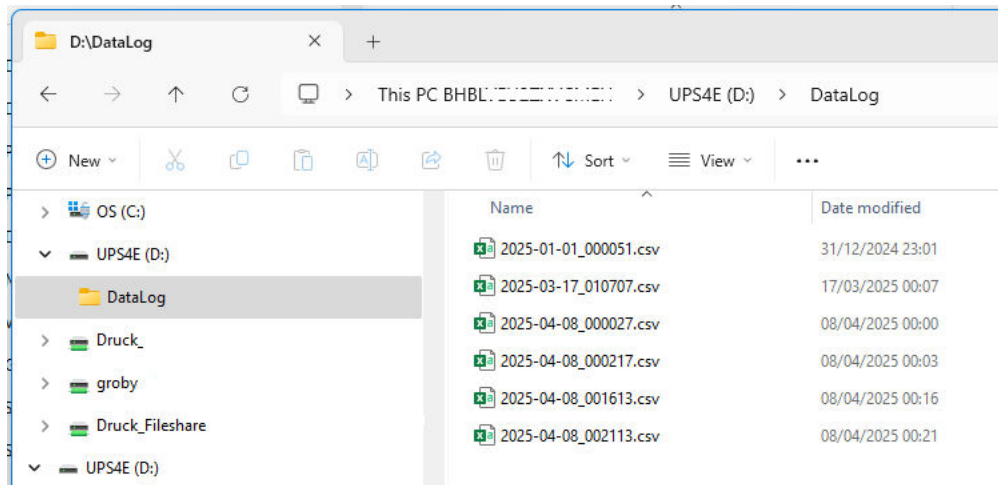

Figure 3-7: Typical PC File Explorer Application Showing Datalog files

6. The Calibrator automatically gives each Datalog file a date and time that it was recorded, in the format YYYY-MM-DD_HHMMSS. For example 2025-04-08_002113 is the year 2025 and the fourth month and the date of the 8th. The time is 21 minutes and 13 seconds past midnight.
7. Select the necessary file and open it with your spreadsheet application to examine it.
8. After use, use the PC to delete any unwanted Datalog files from the Calibrator to empty its memory.

4. Calibration Procedures

Druck can provide a calibration service that is traceable to international standards. We recommend that you return the instrument to us or an approved service agent for calibration. If using an alternative calibration facility, check that it uses the same standards.

4.1 Before Starting

1. Check that the Calibrator battery level is at maximum. Consider changing to new batteries if not.
2. Make sure the calibration environment has a stable temperature of $21 \pm 1^{\circ}\text{C}$ ($70 \pm 2^{\circ}\text{F}$).
3. Make sure your calibration standard instrument covers these ranges as a minimum:
 - Current (mA) input and output range +/- 0 to 24 mA.
 - Voltage (V) output range 0 to +/- 30 VDC.
4. Put the Calibrator and calibration standard instrument in the calibration environment for a minimum of two hours.
5. Connect and energize the Calibrator and the calibration standard instrument using the cables supplied or equivalent high-quality cables.
6. Wait a few minutes for the Calibrator and other instruments to thermally stabilize. Consider changing the AUTO OFF setting to off to avoid disruption while waiting for readings to stabilize during calibration.

4.2 'ADJ' (ADJUST) function

This function adjusts the Calibrator primary reading to the same value as the external calibration instrument when doing current source calibration. It is useful in current and voltage measure calibration when you use calibration values that are different to the preset values. The Calibrator will adjust itself to the external instrument value.

For example, if you need to calibrate measurement at a value of 18 mA instead of the preset 19.5 mA, set your external instruments to 18 mA and use the '**ADJ**' function to adjust the calibrator to set the Primary reading to 18 mA.

4.3 ADV (ADVANCED) button polarity function

You can use ADV button to change the sign (polarity) of the primary reading when using the ADJ (ADJUST) function while doing calibration.

4.4 Calibration Notes

Push the '**MODE**' button or de-energize the Calibrator to escape the calibration setting at any time. If the calibrator shows an error code at any time during the calibration (see "Error Codes and Warnings" on page 54) then it is likely that the calibrated value is incorrect. Push the **Enter** button to accept the error and redo the calibration.

4.5 Preset Calibration Values



INFORMATION The Calibrator has preset calibration values of current and voltage, but you may apply different values and use the ADJ (adjust) to change the reading in the Calibrator to match the applied value.

Table 4-1: Preset Calibration Values

Current Measure (mA) 20 mA range	Current Measure (mA) 24 mA range	Current Source (mA)	Voltage Measure (V) 20 V range	Voltage Measure (V) 30 V range
-19.5	-24.0	+0.2	-20	-30
0	0	+19.5	0	0
+19.5	+24.0	-	+20	+30
Check 1 mA	Check 24 mA	Check 1 mA	Check 20 V	Check 30 V

4.6 Deviation Tolerances

After calibration, go through the Set Point values as suggested in these tables and check that the deviation is within the permissible limits.

4.6.1 Current Measure

- 20 mA range: 12 ppmRdg + 56 ppmFS
- 24 mA range: 22 ppmRdg + 86 ppmFS

Table 4-2: Current Measure Set Point and Deviation Tolerance

Set Point (mA)	Permissible Deviation (mA)
-24	±0.002592
-22	±0.002548
-20	±0.002504
-10	±0.00124
-5	±0.00118
0	±0.00112
5	±0.00118
10	±0.00124
20	±0.002504
22	±0.002548
24	±0.002592

4.6.2 Current Source

- 20 mA range: 13 ppmRdg + 68 ppmFS

- 24 mA range: 22 ppmRdg + 86 ppmFS

Table 4-3: Current Source Set Point and Deviation Tolerance

Set Point (mA)	Permissible Deviation (mA)
0.6	±0.00136
6	±0.00143
12	±0.00151
18	±0.00159
24	±0.0025

4.6.3 Voltage Measure

- 20 V range: 10 ppmRdg + 69 ppmFS
- 30 V range: 10 ppmRdg + 79 ppmFS

Table 4-4: Voltage Measure Set Point and Deviation Tolerance

Set Point (V)	Permissible Deviation (V)
-30	±0.00267
-21	±0.00258
-20	±0.00257
-10	±0.00148
-5	±0.00143
0	±0.00138
5	±0.00143
10	±0.00148
20	±0.00257
21	±0.00258
30	±0.00267

4.7 Calibration Flow

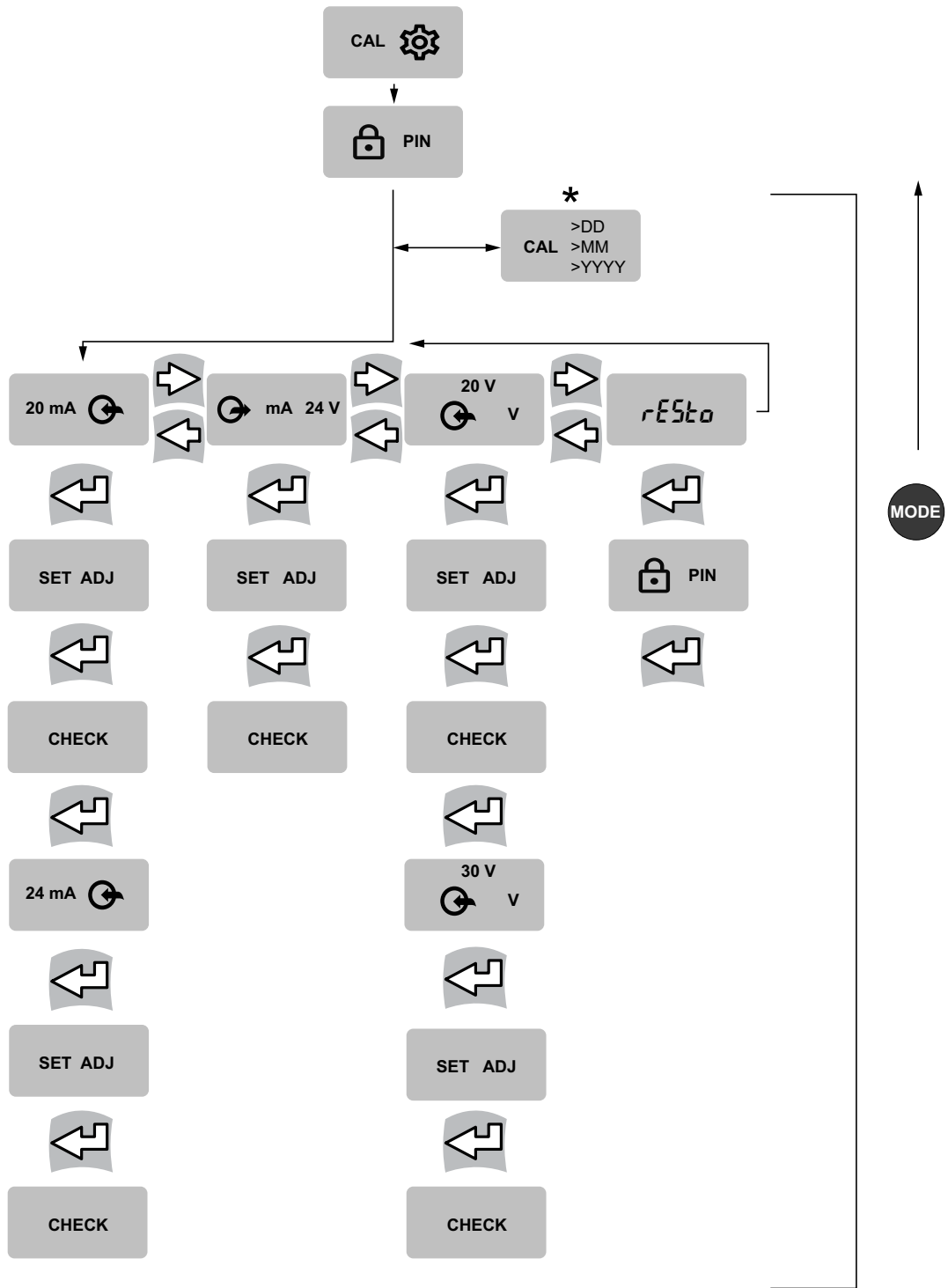

Figure 4-1: Calibration Flow

Note: *The Calibrator will ask for the CAL date and time if it has not already been set.

4.8 Procedure 1: Unlock PIN for Calibration

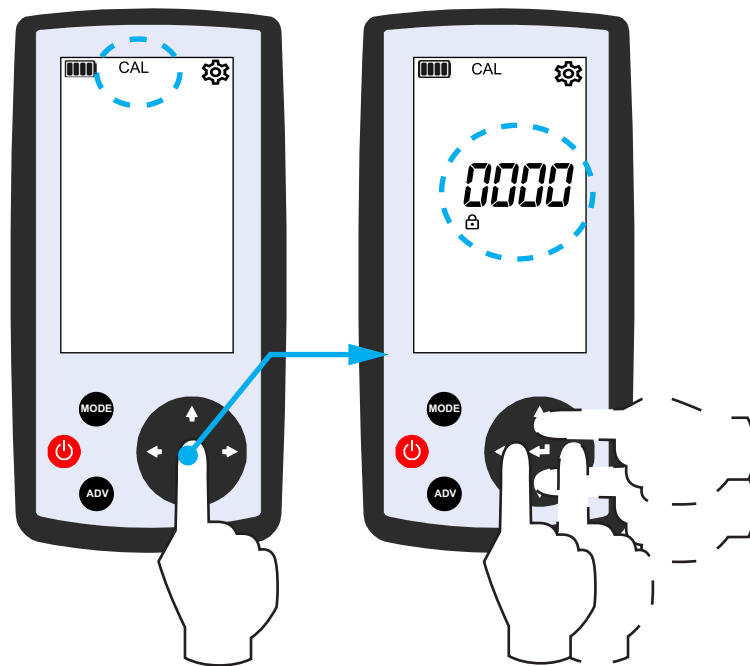

Figure 4-2: Unlock PIN for Calibration

1. On the Calibrator, enter the **Settings** and select the **CAL** (calibration) option. See “Setting - Calibration” on page 20.
 2. The **CAL** symbol will flash. Push the **Enter** button.
 3. The screen will show the **Lock** symbol and the primary reading will change to a set of four digits for the **PIN**.
 4. Use the **Navigation Pad** to enter the correct **PIN** 4321. The left and right buttons will select the digit to be changed and the up and down buttons will change the value of the digit.
 5. Push the **Enter** button to accept the correct **PIN**. The screen will cancel the **Lock** symbol.
- Note:** If you have not already entered the calibration date, the Calibrator will ask you to enter it before doing the calibrations. See “Setting - Calibration Date” on page 21.
6. You will now have the choice of calibrating current measure, current source or voltage.

4.9 Procedure 2: Current (Measure)

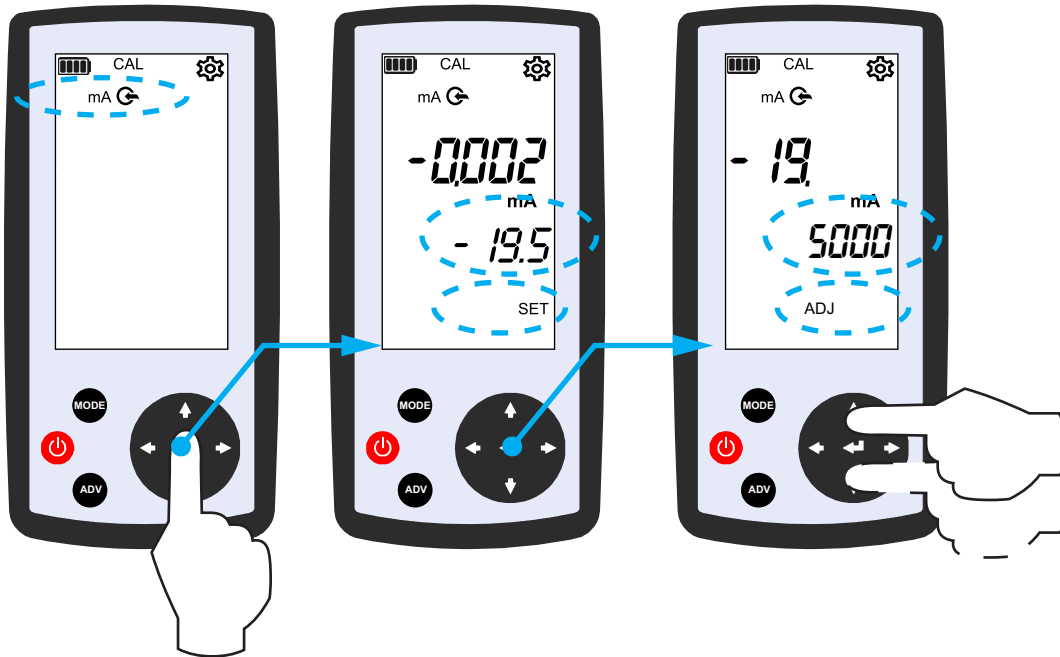

Figure 4-3: Calibration – Current Measure

1. When you select this option the **mA** and **measure** symbols will flash. Use the **Navigation** left and right buttons to move to the next calibration procedure or push the **Enter** button to accept. The screen will show the **SET** symbol.
2. The Calibrator will take you through two ranges; one uses steps of the preset calibration values for the 20 mA range, the second uses steps of the preset calibration values for the 24 mA range. The secondary reading will show the preset calibration values. At each step, set your external calibrator to the preset value, or to your preferred chosen value of calibration.
3. The primary reading will show the measured values at each step. Wait up to minute to make sure the measured value remains stable before you push **Enter** to accept. The Calibrator will accept the applied current as a calibrated value and readjust itself.
4. The **ADJ** symbol will flash to allow you to adjust the primary reading to the same value as the current from the calibrated instrument using the **Navigation Pad** up and down and left and right buttons. This is useful if using calibrated values that are different to the preset values. You do not need to use this adjustment if you are using the preset values.
5. Push the **Enter** button to accept.
6. At the last steps, the Calibrator will recommend values of 1 mA and 24 mA and show **CHECK**. Apply the recommended value and push **Enter** to accept.

4.10 Procedure 3: Current (Source)

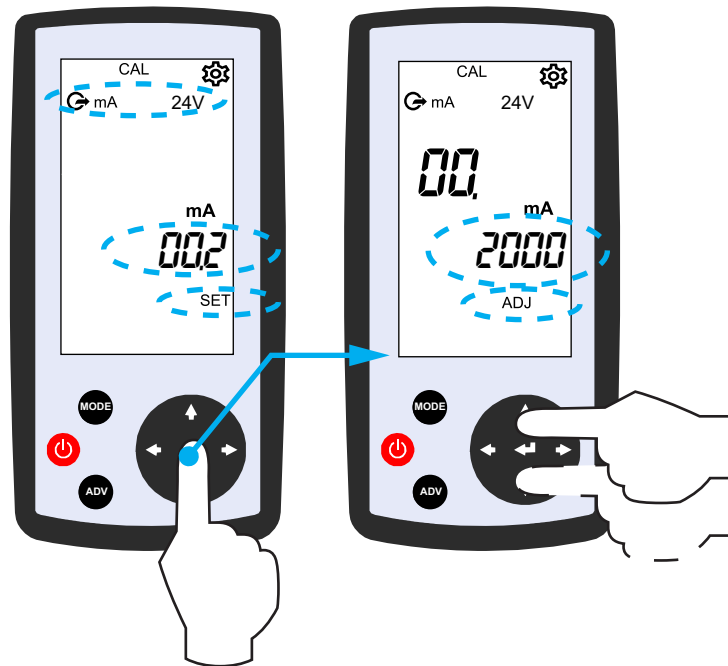

Figure 4-4: Calibration – Current Source

1. When you select this option the **mA**, **source** and **24 V** symbols will flash. Use the **Navigation** left and right buttons to move to the next calibration procedure or push the **Enter** button to accept. The screen will show the **SET** symbol.

Note: The Calibrator automatically selects the internal 24 V source for this calibration. You cannot deselect it.

2. The Calibrator will take you through steps of the preset calibration values. The secondary reading will show the preset calibration values. At each step, set your external calibrator to view the preset value.
3. This procedure is different to the others - the secondary screen will flash at each step to allow you to change the source current for calibration to a value different from the preset value if necessary.
4. Push **Enter** to accept the setpoint.
5. The **ADJ** symbol will flash to allow you to adjust the primary reading to the same value as the current measured at the external calibrated instrument using the **Navigation Pad** up and down and left and right buttons.
6. Wait up to a minute to make sure the measured value at your external instrument remains stable before you push **Enter** to accept.
7. Push the **Enter** button to accept.
8. In the final steps, the Calibrator will recommend a value of 1 mA and show **CHECK**. Wait up to a minute to make sure the measured value at your external instrument remains stable and the same as the value shown on the UPS4E.
9. Push the **Enter** button to accept.

4.11 Procedure 4: Voltage (Measure)

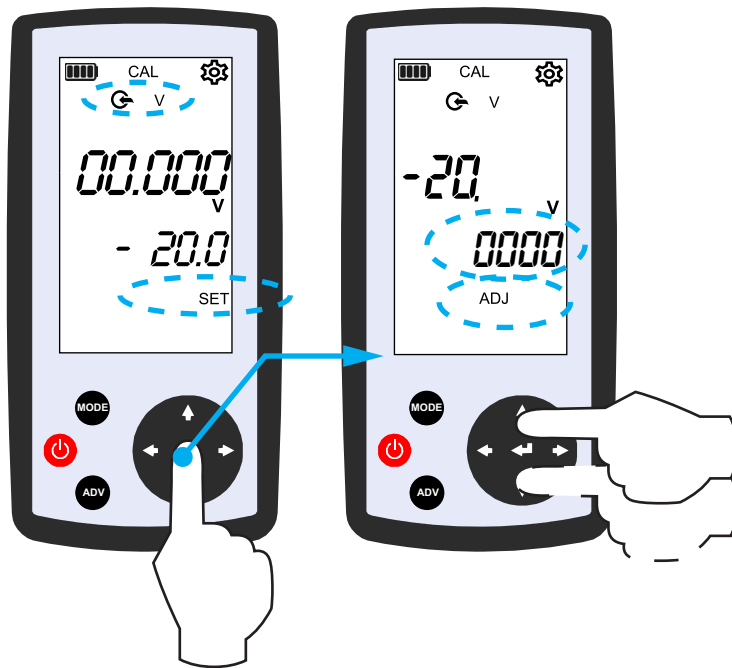

Figure 4-5: Calibration – Voltage Measure

1. When you select this option the **V** and **measure** symbols will flash. Use the **Navigation** left and right buttons to move to the next calibration procedure or push the **Enter** button to accept. The screen will show the '**SET**' symbol.
2. The Calibrator will take you through two ranges; one uses steps of the preset calibration values for the 20 V range, the second uses steps of the preset calibration values for the 30 V range. The secondary reading will show the preset calibration values. At each step, set your external calibrator to the preset value, or to your preferred chosen value of calibration.
3. The primary reading will show the measured values at each step. Wait up to a minute to make sure the measured value remains stable before you push **Enter** to accept. The Calibrator will accept the applied voltage as a calibrated value and readjust itself.
4. The **ADJ** symbol will flash to allow you to adjust the primary reading to the same value as the voltage from the calibrated instrument using the **Navigation Pad** up and down and left and right buttons. This is useful if using calibrated values that are different to the preset values. You do not need to use this adjustment if you are using the preset values.
5. Push the **Enter** button to accept.
6. At the last steps, the Calibrator will recommend values of 20 V and 30 V and show **CHECK**. Apply the recommended value and push **Enter** to accept.

4.12 Calibration Restore

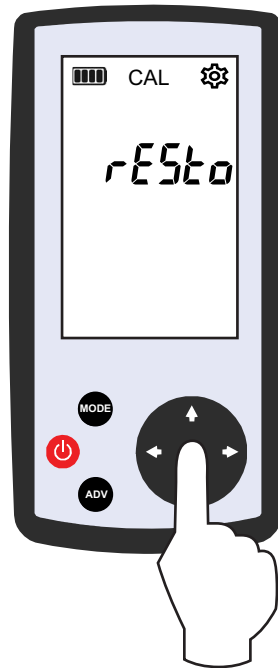

Figure 4-6: Calibration Restore

This option restores the Calibrator calibration to its factory conditions. If the factory calibration conditions have been damaged or are missing, then the screen will show '**FAIL**'. If this happens, contact Druck for more details. If the restore works correctly, then the Calibrator will return to its factory calibration conditions.

1. When you select this option the primary reading will show '**rESto**'. Push the **Enter** button and the Calibrator will ask for a four digit PIN 4321.
2. Use the **Navigation Pad** up, down and left and right buttons to select and change the digits. Select **Enter** to accept. The primary reading will show '**PASS**'.

5. Specifications

Refer to the product Datasheet for a full specification of the Calibrator:

Druck.com

The Calibrator is suitable for indoor use with the following environmental requirements. It is also permitted to use outdoors as a portable instrument if the environmental requirements are met.

Item	Description
Dimensions	UPS4E: 145 mm high x 73 mm wide x 25 mm UPS4E-IS: 145 mm high x 74 mm wide x 35 mm
Weight	UPS4E: 318 g UPS4E-IS: 382 g including batteries
Display Screen	Custom Segment Monochrome Liquid Crystal Display
Measurement Range (Current)	0 mA to +/-20 mA +/-4 mA to +/-20 mA
Measurement Range (Voltage)	0 V to +/-30 VDC
Internal Current Source	24 V and 24 mA maximum
External Loop Supply limit	30 V maximum
Continuity Range	<100 ohm short circuit >1000 ohm open circuit
Internal HART loop resistor	Nominal 250 ohm
Operating Temperature range	-10 to 50°C (14 to 122°F)
Storage Temperature range	-20 to 70°C (-4 to 158°F)
Ingress Protection	IP54
Humidity range	0 to 90% relative humidity (RH) non-condensing.
Shock/Vibration	MIL-PRF-28800F for class 2 equipment.
Pollution Degree	2
EMC	Electromagnetic Compatibility: EN 61326-1:2013
Electrical Safety	EN 61010-1:2010 EN 61010-2-030:2023
Approvals	See product label
Battery Power	4 x Type AA Cells. Nominal voltage: 1.5 V each cell. Alkaline only. Not rechargeable.
UPS4E-IS Battery Type	Varta Industrial Pro AA or Duracell Plus AA
Connectors	4 mm sockets
Linear Function preset steps	4, 8, 12, 16 and 20 mA (4-20 mA range) 0, 5, 10, 15 and 20 mA (0-20 mA range)
Flow Function preset steps	4, 5, 8, 13 and 20 mA (4-20 mA range) 0, 1.25, 5, 11.25 and 20 mA (0-20 mA range)

Chapter 5. Specifications

Item	Description
Valve Function preset steps	3.8, 4, 4.2, 12, 19, 20 and 21 mA (4-20 mA range) 0, 0.2, 10, 19, 20, 21 mA (0-20 mA range)
Auto Step, Ramp and Auto Ramp time	1 to 599 seconds
Auto Power Off	After 10 minutes of no button pushes (if enabled). Disabled if data logging or if USB power connected.
Data Log	Interval up to 1 min Duration up to 99 hours and 59 minutes CSV file format
Calibration Enter PIN	4321
Calibration Restore PIN	4321
Firmware Update PIN	5487
USB	Type C USB 2.0 UPS4E: Input 5 V 500 mA UPS4E-IS: Data Transfer only

6. Maintenance

THE EQUIPMENT CONTAINS NO USER SERVICEABLE PARTS. INTERNAL COMPONENTS MAY BE UNDER PRESSURE OR PRESENT OTHER HAZARDS. SERVICING, MAINTAINING, OR REPAIRING THE EQUIPMENT MAY RESULT IN DAMAGE TO PROPERTY AND SERIOUS PERSONAL INJURY (INCLUDING DEATH). THEREFORE IT IS PARAMOUNT THAT SERVICE ACTIVITIES ARE UNDERTAKEN ONLY BY A DRUCK AUTHORIZED SERVICE PROVIDER.

REPAIR ACTIVITIES UNDERTAKEN BY UNAUTHORIZED PERSONNEL MAY INVALIDATE THE EQUIPMENT WARRANTY, SAFETY APPROVALS AND DESIGN CONDITION. DRUCK CANNOT BE HELD LIABLE FOR ANY DAMAGES (INCLUDING DAMAGE TO THE EQUIPMENT), MONETARY FINES, PROPERTY DAMAGE OR PERSONAL INJURY (INCLUDING DEATH) THAT MAY OCCUR DURING OR AS A RESULT OF SERVICE MAINTENANCE OR REPAIR WORK UNDERTAKEN BY AN UNAUTHORIZED SERVICE PROVIDER.

6.1 Cleaning



CAUTION Do not use solvents or abrasive materials.

Clean the case and screen with a lint-free cloth and a weak detergent solution.

6.2 Installing and Changing the Batteries

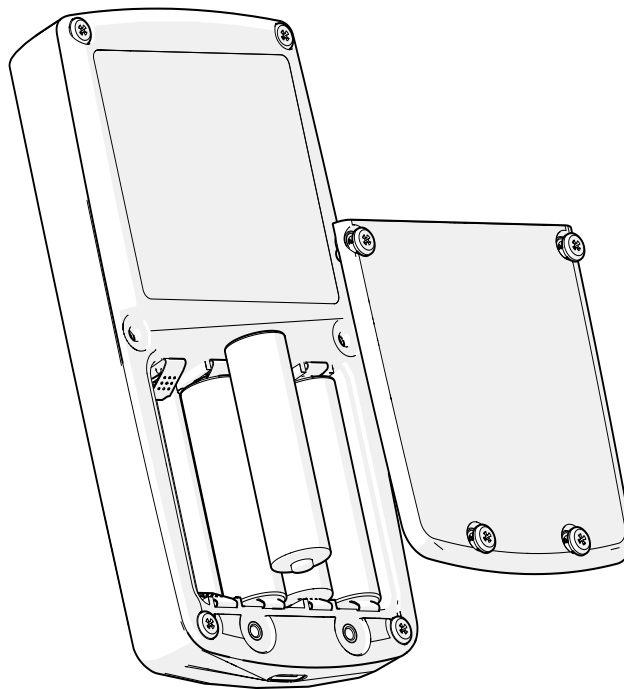

Figure 6-1: Installing the Batteries

Note: Replace all four batteries at the same time.

1. Use a Pozidriv screwdriver to unscrew the captive screws that secure the battery compartment cover. See Figure 6-1.
2. Remove exhausted batteries and insert new batteries into the compartment. Make sure battery polarities are as shown on the battery cover. Refer to “Specifications” on page 49 for battery types.

Chapter 6. Maintenance

3. Replace the battery cover and secure the screws.
4. Push the Power button to check that the Calibrator works.



CAUTION Remove or replace the batteries immediately if they are exhausted. Recycle them according to your local regulations.

6.3 Continuity Check

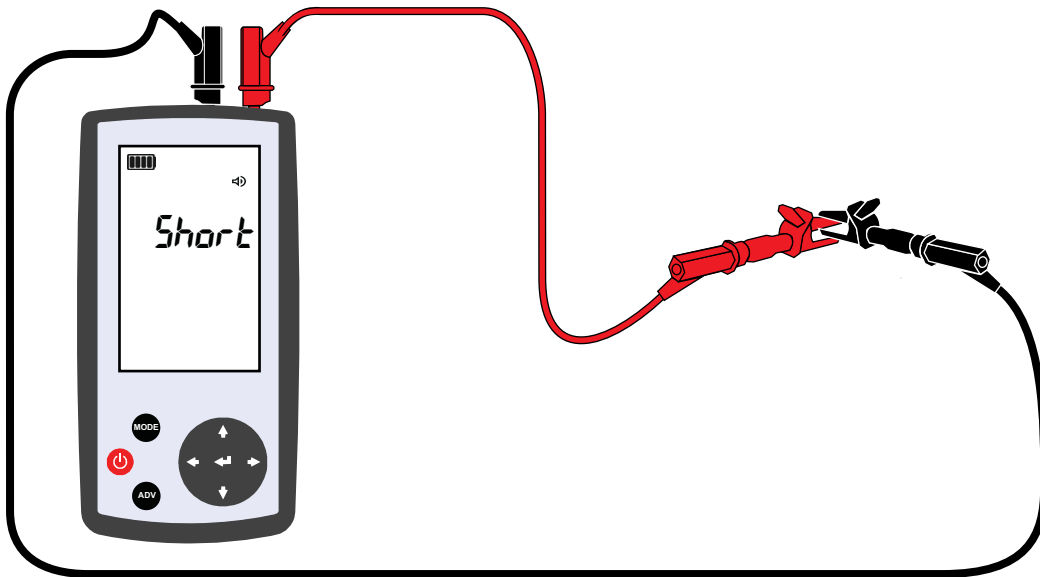
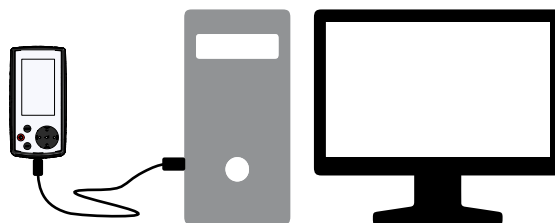

Figure 6-2: Continuity Check

There is no adjustment for the continuity calibration, so this is a simple procedure to make sure the continuity check works correctly.

1. Set the Calibrator to do a Continuity test. See “Voltage Measuring and Continuity Test Modes” on page 25.
2. Using the leads supplied with the Calibrator, connect both leads together and check that the Calibrator indicates a short circuit and the buzzer operates.
3. Disconnect the leads and make sure the Calibrator shows open circuit.
4. If the test fails, check the leads for damage and replace if necessary.

6.4 Updating the Firmware



There are two ways to update the firmware in the Calibrator. For both, you will need to connect the Calibrator to a suitable PC using the USB cable supplied with the Calibrator.

6.4.1 Method 1.

1. Your PC must have an internet connection.
2. Go to the UPS4E download portal on the Druck website and follow the instructions you find there.

<https://druck.com/software>

6.4.2 Method 2.

1. You must have a copy of the latest firmware downloaded from the Druck website at **<https://druck.com/software>** and stored on your PC. The files can be in a zipped format, so you must unzip (extract) them before use.
2. Turn on the Calibrator.
3. Connect the Calibrator to the PC. The screen of the Calibrator will show the USB symbol



and 'VCP'.

4. Change the USB mode to MSC. See "Setting - USB" on page 18.

Note: When you have entered the MSC USB mode, do not press any further buttons on the Calibrator until step 6, or it will return to its default VCP mode.

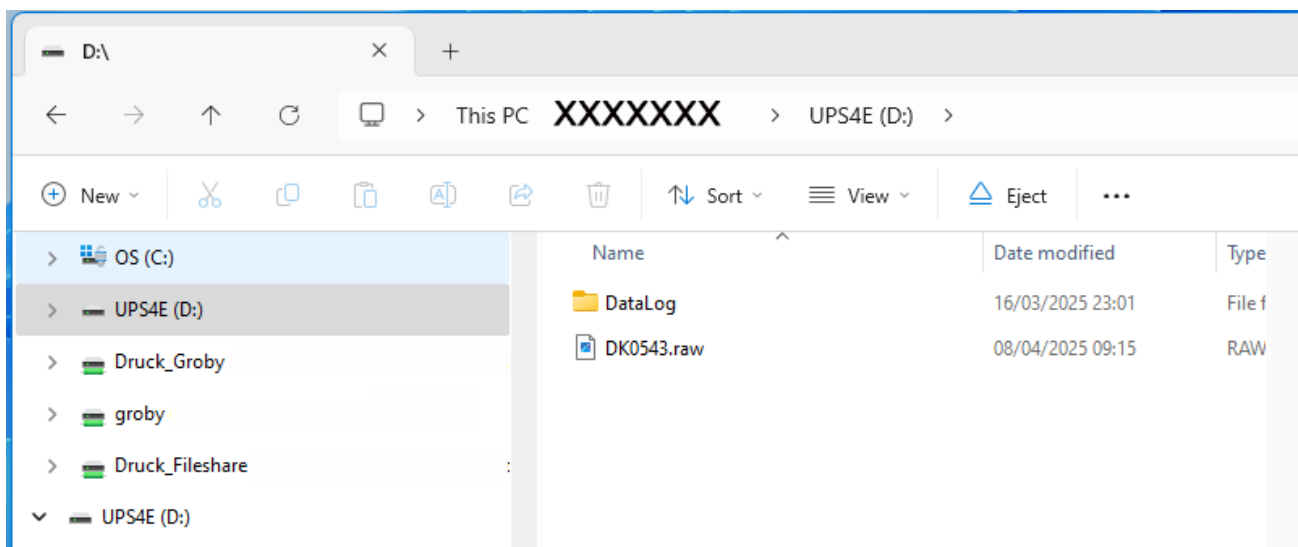

Figure 6-3: Typical PC Explorer Application Showing the Firmware file

5. On the PC, open a file explorer application. You will see the Calibrator as a mass storage device (UPS4E (D:) in the image), containing the **Datalog** folder and the firmware (*.raw) file (DK0543.raw in this example). Delete the existing firmware file from the Calibrator and replace with the latest firmware file.
6. On the Calibrator, press the up and down **Navigation Pad** buttons together to open the **Settings**. Refer to "To Open the Settings" on page 17.
7. Use the Navigation buttons to select the **FW UPDATE**.
8. The screen will show the lock symbol asking for you to enter the four digit PIN number 5487. Use the **Navigation Pad** to select each digit and change its value. Then push **Enter**.
9. The primary reading will show **Enter**.

Chapter 6. Maintenance

10. Push the **Enter** button. The Calibrator will restart, then start to load the new firmware while showing a counter that goes from 0 to 99%. It will then restart again.

6.5 Error Codes and Warnings

The Calibrator can show one of several error codes and warnings on the screen. These codes and warnings can warn you that you are using the Calibrator incorrectly or need to retry an operation.

6.5.1 Error Codes

Error Code	Cause and remedy
E01, E02, E03, E06	Software and hardware failures. Contact Druck service.
E04	Voltage out of range. Apply 0 to +/- 30 V
E05	Current out of range. Apply 0 to +/- 24 mA
E07	Firmware upgrade error. Try the upgrade again.
E13	Calibration error. Try the calibration again.
E14	PIN error. Try again with the correct PIN.
E15	Data logging error. Check that the Datalog folder (memory) has sufficient space for the Datalog file you are about to create. Delete unwanted Datalog files.
E16	Check the external voltage applied, it should be within +/- 30 V. Push Enter to acknowledge the error. Contact Druck Service if the error persists.

6.5.2 Warnings

Warnings	Cause and remedy
Lo Bat	Battery level critical. Change to new batteries or connect USB power source.
CAL DUE	Shown on the screen if it has been more than 365 days from the last device calibration date. We recommend that you calibrate the instrument when you see this, but this warning does not stop device operation.
No Fil	(No file found) errors. Shown on the screen if the firmware update cannot be done either due to low battery or no firmware file found in UPS4E. Change for fresh batteries if necessary or connect to a USB power source. Copy the correct firmware file again to the device.
Loop	Loop error. Only shown in VALVE - AUTO SPAN mode. Open circuit loop. Check connections.

6.6 Instrument Return

6.6.1 Return Goods/Material Procedure

If the unit requires calibration or is unserviceable, return it to the nearest Druck Service Centre. See rear page.

Contact the Service Department to obtain a Return Goods/Material Authorization (RGA or RMA). Provide the following information for a RGA or RMA:

- Product (e.g. UPS4E)
- Serial number.
- Details of defect/work to be undertaken.
- Calibration traceability requirements.
- Operating conditions.

6.7 Packaging for Storage or Transportation

1. Suitably pack the Calibrator and its cables. Re-use the original packaging if possible.
2. To return the instrument for calibration or repair, complete the return goods procedure. See Section 6.6. Return the instrument to the manufacturer or an approved service agent for all repairs.

Refer to “Specifications” for storage and transportation conditions.

Office Locations



<https://druck.com/contact>

Services and Support Locations



<https://druck.com/service>